

Description: 2X2 MIMO Dual WiFi Antenna

Series: FPC Antenna

PART NUMBER: W6102B0100

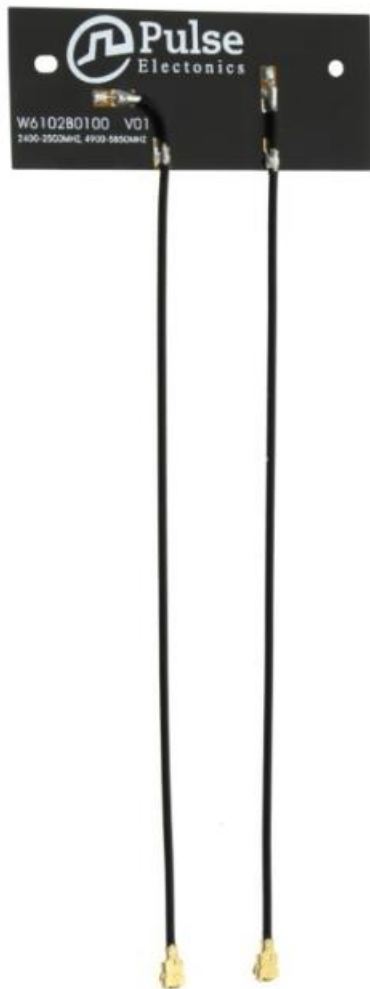

Features:

- Port 1: 2.4-2.5/4.9-5.925GHz
- Port 2: 2.4-2.5/4.9-5.925GHz
- Supports dual band WiFi and DSRC bands
- Size 50x20mm
- Cables 100mm 1.13mm OD
- U.FL compatible connectors

Applications:

- WiFi, Zigbee, Bluetooth radios
- ISM 2.4GHz and 5GHz
- DSRC 5925MHz
- Routers, Gateways, Security
- Transportation
- M2M, IoT

Issue: 1701

In the effort to improve our products, we reserve the right to make changes judged to be necessary.

CONFIDENTIAL AND PROPRIETARY INFORMATION

This document contains confidential and proprietary information of Pulse Electronics, Inc. (Pulse) and is protected by copyright, trade secret and other state and federal laws. Its receipt or possession does not convey any rights to reproduce, disclose its contents, or to manufacture, use or sell anything it may describe. Reproduction, disclosure or use without specific written authorization of Pulse is strictly forbidden.

For more information:

Pulse Worldwide Headquarters
12220 World Trade Drive
San Diego, CA 92128
USA
Tel: 1-858-674-8100

Pulse/Larsen Antennas
18110 SE 34th St Bldg 2 Suite 250
Vancouver, WA 98683
USA
Tel: 1-360-944-7551

Europe Headquarters
Pulse GmbH & Do, KG
Zeppelinstrasse 15
Herrenberg, Germany
Tel: 49 7032 7806 0

Pulse (Suzhou) Wireless Products Co, Inc.
99 Huo Ju Road(#29 Bldg,4th Phase
Suzhou New District
Jiangsu Province, Suzhou 215009 PR China
Tel: 86 512 6807 9998



Description: 2X2 MIMO Dual WiFi Antenna

Series: FPC Antenna

PART NUMBER: W6102B0100

ELECTRICAL SPECIFICATIONS

Frequency	2.4-2.5/4.9-5.925GHz
Nominal Impedance	50Ω
VSWR	<2
Gain	2dBi+/- 1dB@ 2.4GHz 6dBi+/-1dB@5GHz
Radiation Pattern	Omni
Polarization	Linear
Power withstanding	3W
Connector type	U.FL compatible
Cable type	Low loss Φ1.13mm Coaxial Cable
Cable length	100mm

(*) All RF parameters measured on 2mm thick PC plate

Description: 2X2 MIMO Dual WiFi Antenna**Series: FPC Antenna****PART NUMBER: W6102B0100****MECHANICAL SPECIFICATIONS**

Color	Black
Weight	1.22 g
Overall Length	50 mm
Radiator Thickness with adhesive tape	0.2 mm
Fixing system	Adhesive Tape, 3M6677 PC

ENVIRONMENTAL SPECIFICATIONS

Operating temperature	-40~ +85° C
-----------------------	-------------

Issue: 1701

In the effort to improve our products, we reserve the right to make changes judged to be necessary.

CONFIDENTIAL AND PROPRIETARY INFORMATION

This document contains confidential and proprietary information of Pulse Electronics, Inc. (Pulse) and is protected by copyright, trade secret and other state and federal laws. Its receipt or possession does not convey any rights to reproduce, disclose its contents, or to manufacture, use or sell anything it may describe. Reproduction, disclosure or use without specific written authorization of Pulse is strictly forbidden.

Description: 2X2 MIMO Dual WiFi Antenna

Series: FPC Antenna

PART NUMBER: W6102B0100

MECHANICAL DRAWING

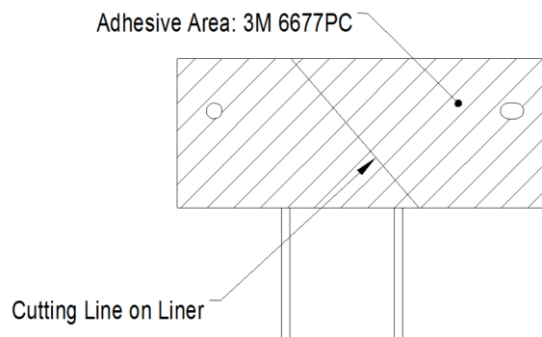
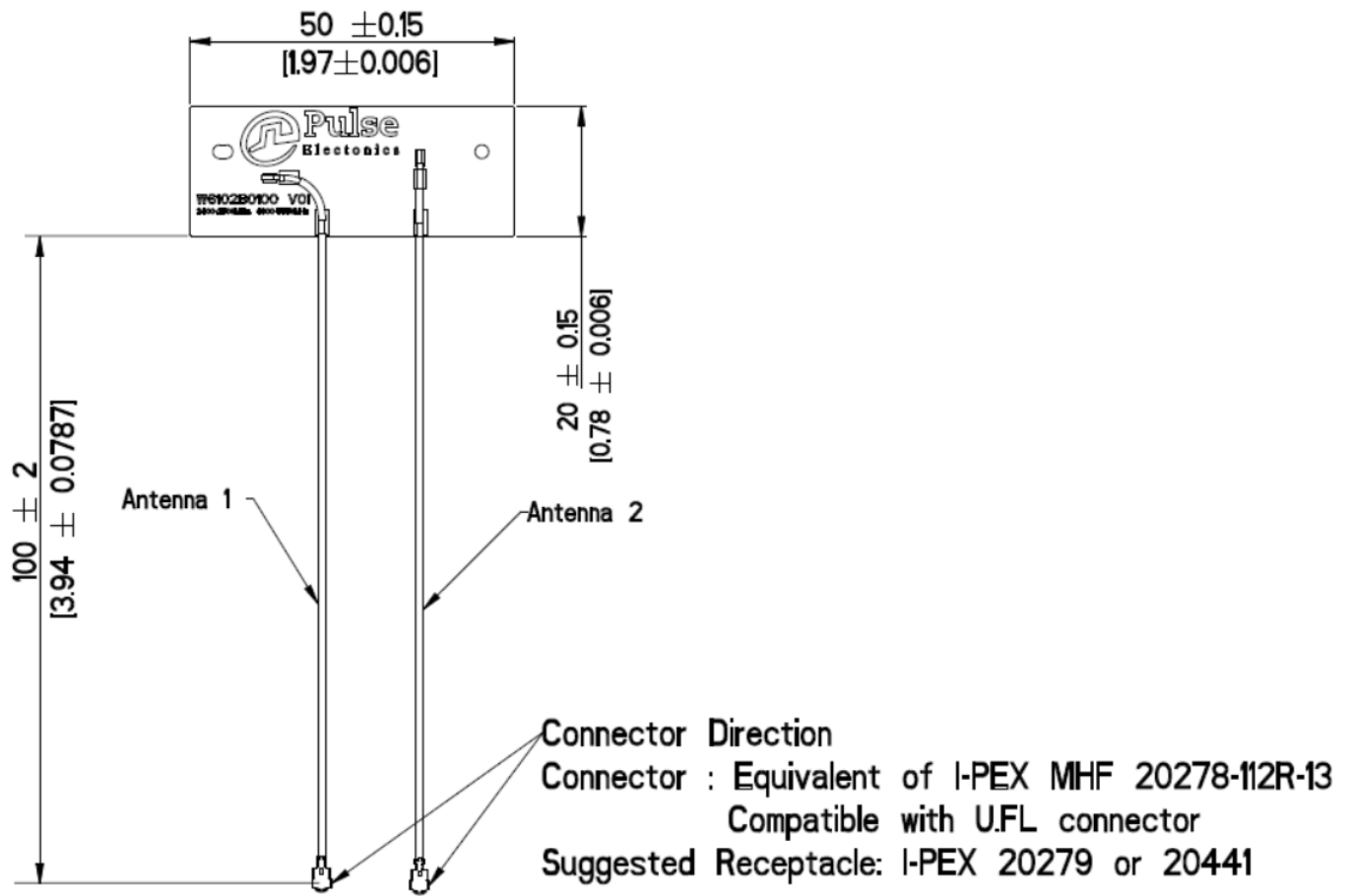

Issue: 1701

In the effort to improve our products, we reserve the right to make changes judged to be necessary.

CONFIDENTIAL AND PROPRIETARY INFORMATION

This document contains confidential and proprietary information of Pulse Electronics, Inc. (Pulse) and is protected by copyright, trade secret and other state and federal laws. Its receipt or possession does not convey any rights to reproduce, disclose its contents, or to manufacture, use or sell anything it may describe. Reproduction, disclosure or use without specific written authorization of Pulse is strictly forbidden.

Description: 2X2 MIMO Dual WiFi Antenna

Series: FPC Antenna

PART NUMBER: W6102B0100

CHARTS

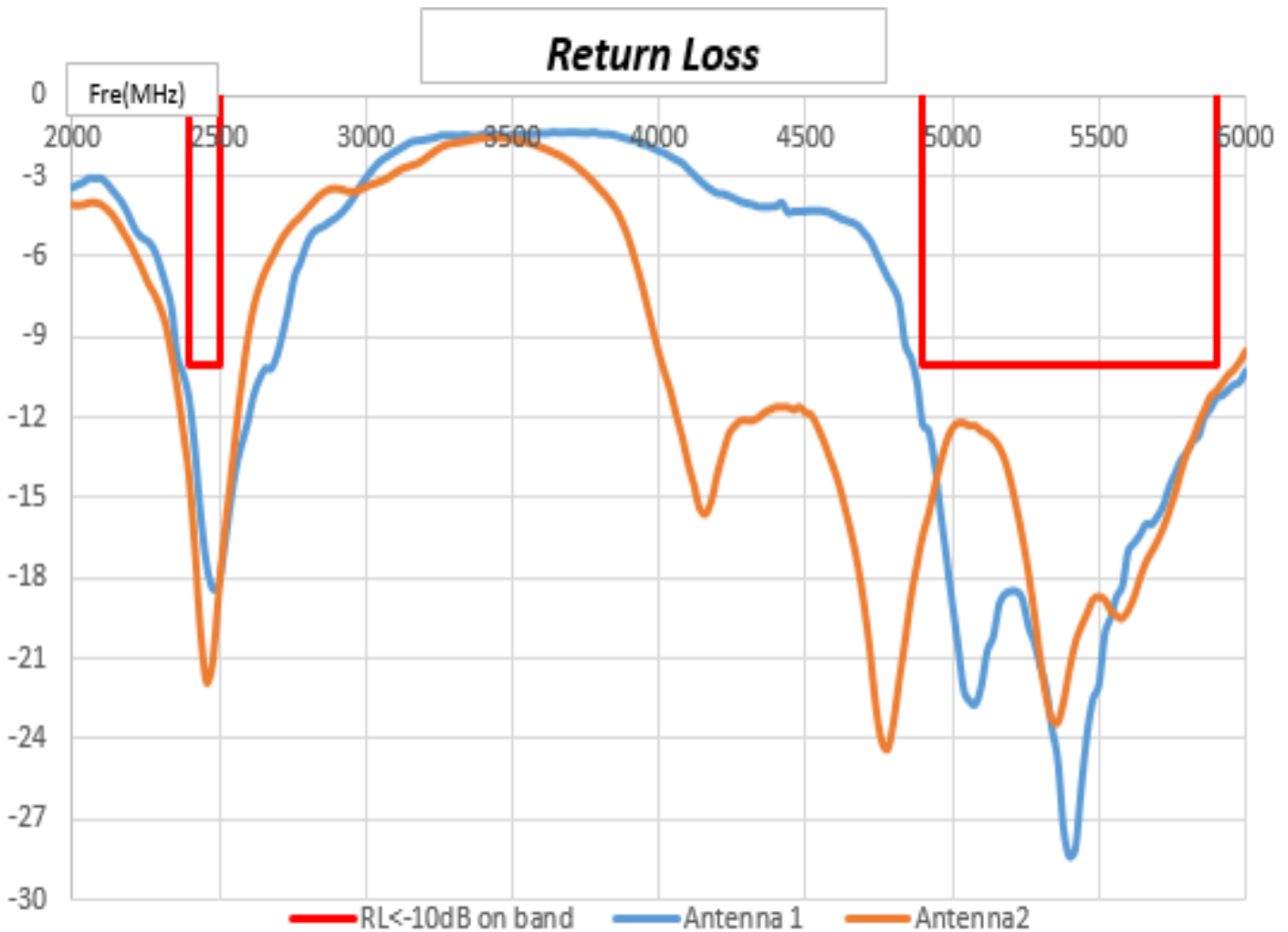

(* All RF parameters measured on 2mm thick PC plate

Issue: 1701

In the effort to improve our products, we reserve the right to make changes judged to be necessary.

CONFIDENTIAL AND PROPRIETARY INFORMATION

This document contains confidential and proprietary information of Pulse Electronics, Inc. (Pulse) and is protected by copyright, trade secret and other state and federal laws. Its receipt or possession does not convey any rights to reproduce, disclose its contents, or to manufacture, use or sell anything it may describe. Reproduction, disclosure or use without specific written authorization of Pulse is strictly forbidden.

Description: 2X2 MIMO Dual WiFi Antenna

Series: FPC Antenna

PART NUMBER: W6102B0100

CHARTS

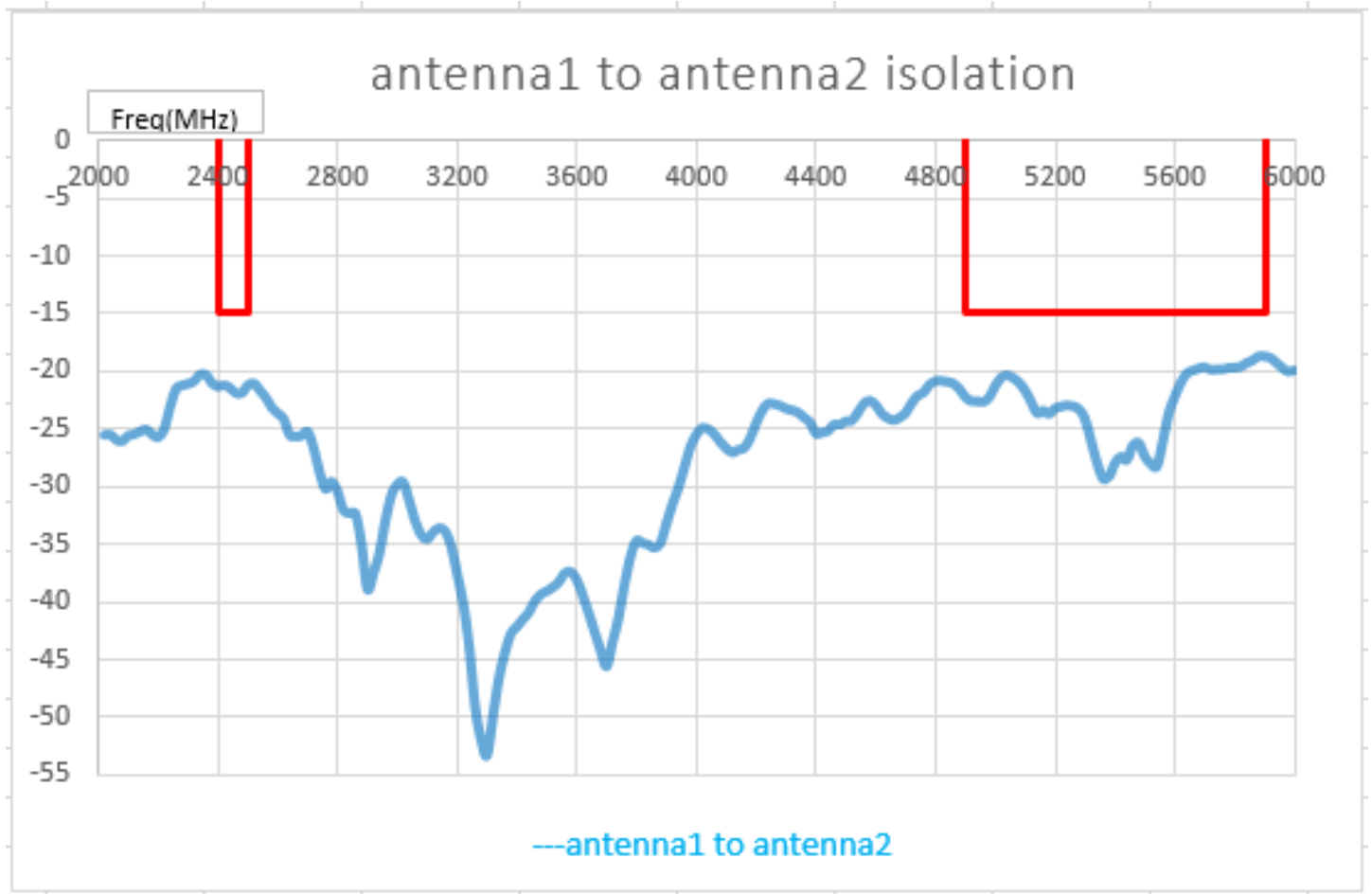

(* All RF parameters measured on 2mm thick PC plate

Issue: 1701

In the effort to improve our products, we reserve the right to make changes judged to be necessary.

CONFIDENTIAL AND PROPRIETARY INFORMATION

This document contains confidential and proprietary information of Pulse Electronics, Inc. (Pulse) and is protected by copyright, trade secret and other state and federal laws. Its receipt or possession does not convey any rights to reproduce, disclose its contents, or to manufacture, use or sell anything it may describe. Reproduction, disclosure or use without specific written authorization of Pulse is strictly forbidden.

Description: 2X2 MIMO Dual WiFi Antenna

Series: FPC Antenna

PART NUMBER: W6102B0100

CHARTS

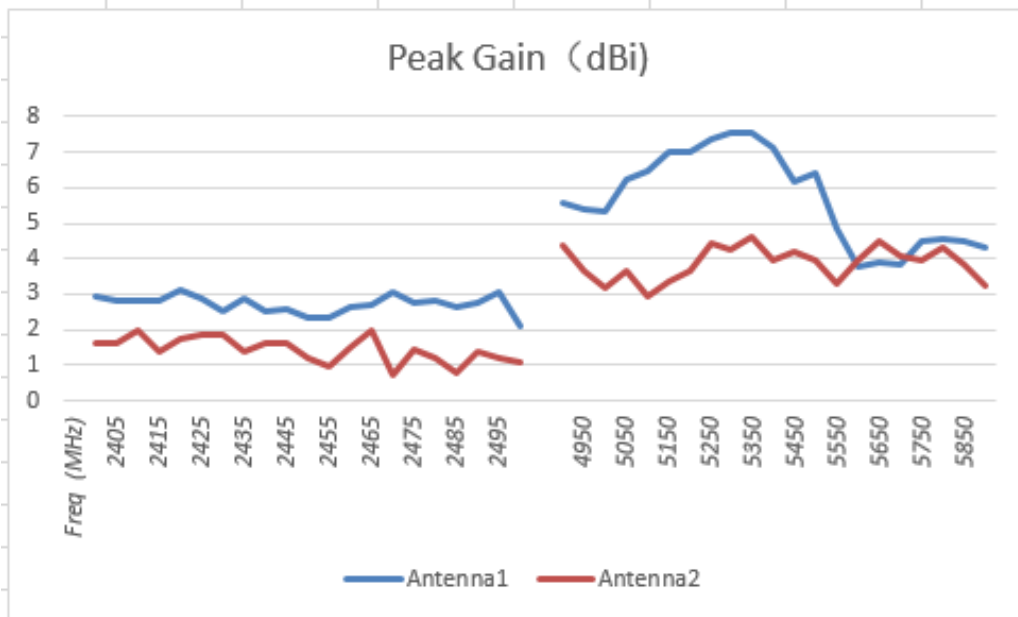
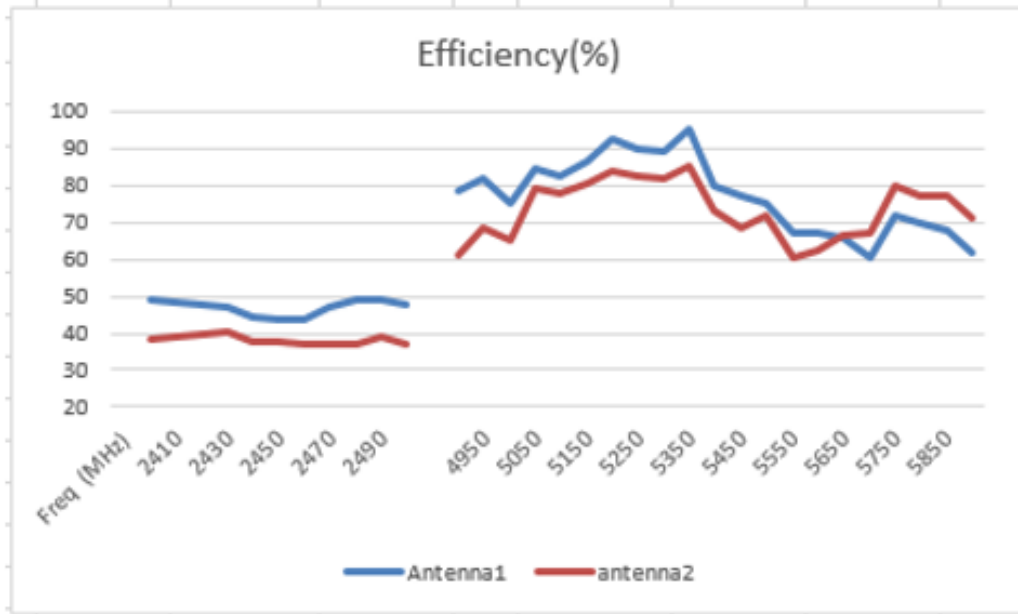

(*) All RF parameters measured on 2mm thick PC plate

Issue: 1701

In the effort to improve our products, we reserve the right to make changes judged to be necessary.

CONFIDENTIAL AND PROPRIETARY INFORMATION

This document contains confidential and proprietary information of Pulse Electronics, Inc. (Pulse) and is protected by copyright, trade secret and other state and federal laws. Its receipt or possession does not convey any rights to reproduce, disclose its contents, or to manufacture, use or sell anything it may describe. Reproduction, disclosure or use without specific written authorization of Pulse is strictly forbidden.

Description: 2X2 MIMO Dual WiFi Antenna

Series: FPC Antenna

PART NUMBER: W6102B0100

CHARTS

Typical free space radiation pattern—Antenna1: 2.4-2.5GHz
 (*) All RF parameters measured on 2mm thick PC plate

XY plane

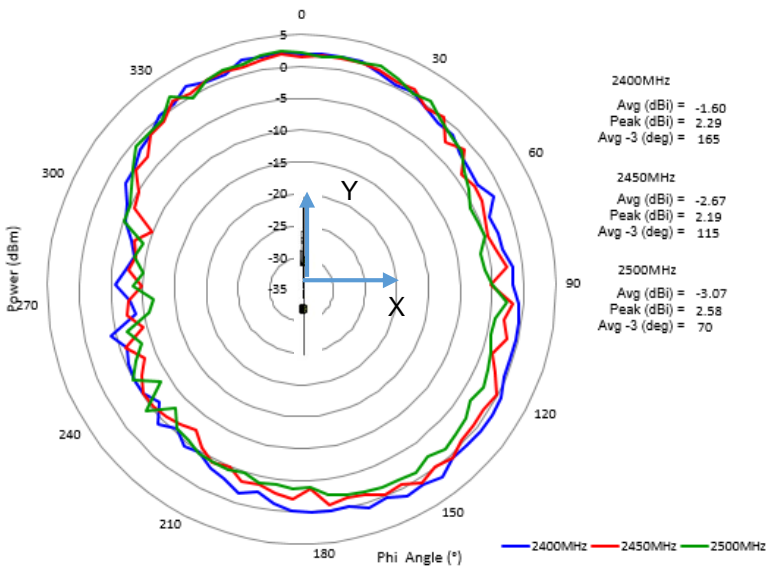

ZX plane

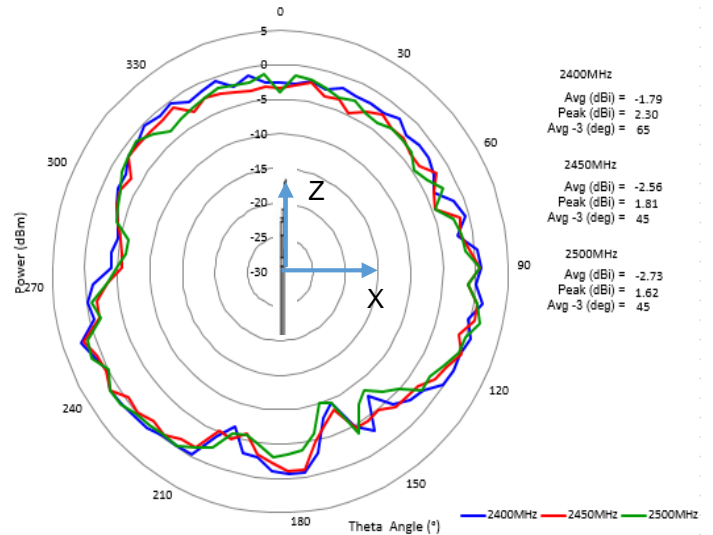

YZ plane

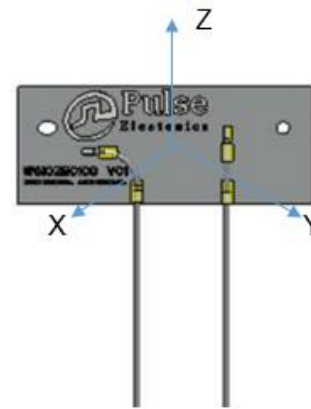
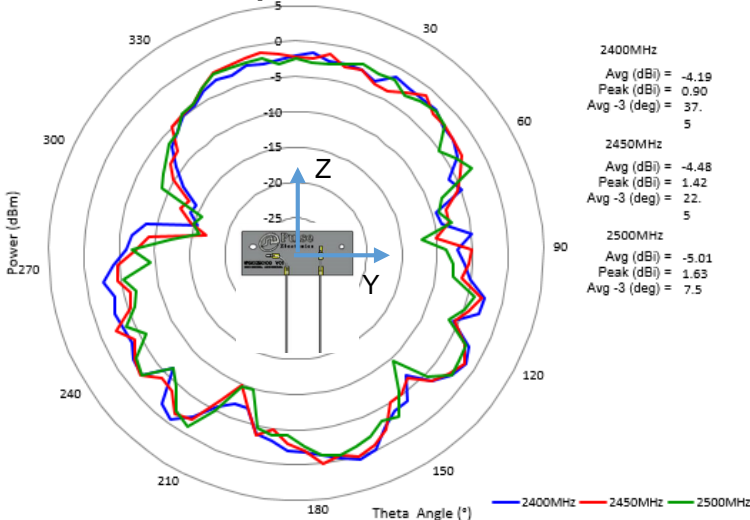

Issue: 1701

In the effort to improve our products, we reserve the right to make changes judged to be necessary.

CONFIDENTIAL AND PROPRIETARY INFORMATION

This document contains confidential and proprietary information of Pulse Electronics, Inc. (Pulse) and is protected by copyright, trade secret and other state and federal laws. Its receipt or possession does not convey any rights to reproduce, disclose its contents, or to manufacture, use or sell anything it may describe. Reproduction, disclosure or use without specific written authorization of Pulse is strictly forbidden.

Description: 2X2 MIMO Dual WiFi Antenna

Series: FPC Antenna

PART NUMBER: W6102B0100

CHARTS

Typical free space radiation pattern—Antenna1: 4.9-5.925GHz
 (*) All RF parameters measured on 2mm thick PC plate

XY plane

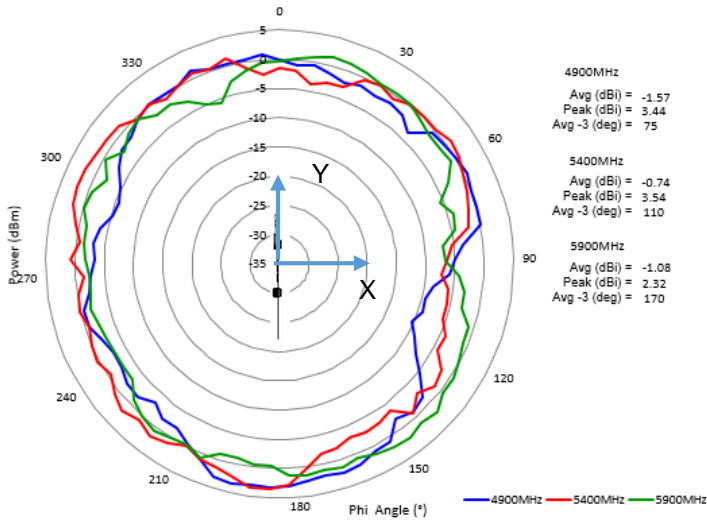

ZX plane

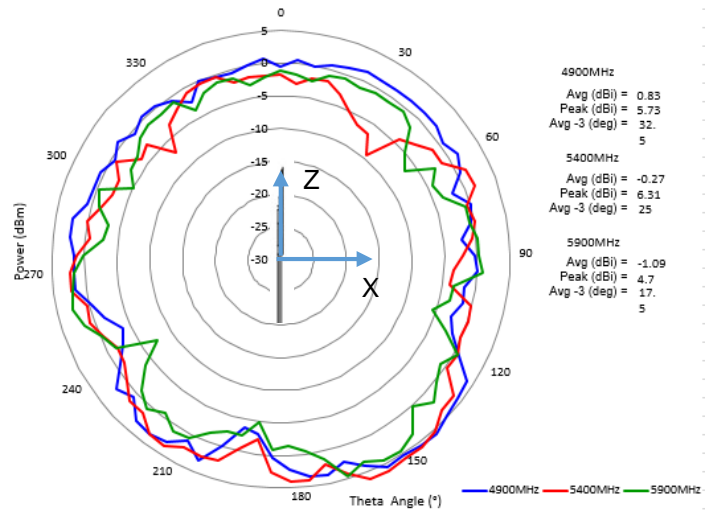

YZ plane

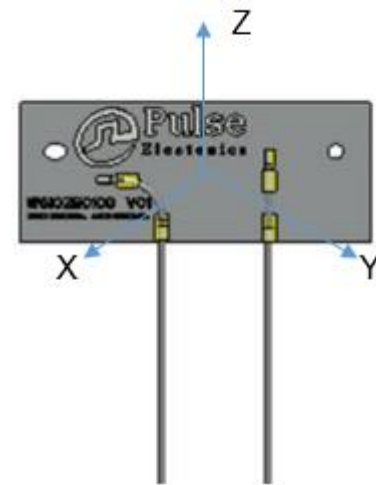
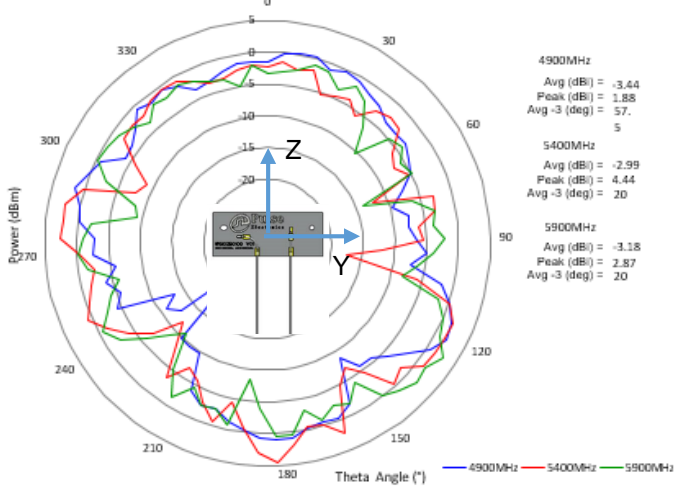

Issue: 1701

In the effort to improve our products, we reserve the right to make changes judged to be necessary.

CONFIDENTIAL AND PROPRIETARY INFORMATION

This document contains confidential and proprietary information of Pulse Electronics, Inc. (Pulse) and is protected by copyright, trade secret and other state and federal laws. Its receipt or possession does not convey any rights to reproduce, disclose its contents, or to manufacture, use or sell anything it may describe. Reproduction, disclosure or use without specific written authorization of Pulse is strictly forbidden.

Description: 2X2 MIMO Dual WiFi Antenna

Series: FPC Antenna

PART NUMBER: W6102B0100

CHARTS

Typical free space radiation pattern—Antenna2: 2.4-2.5GHz
 (*) All RF parameters measured on 2mm thick PC plate

XY plane

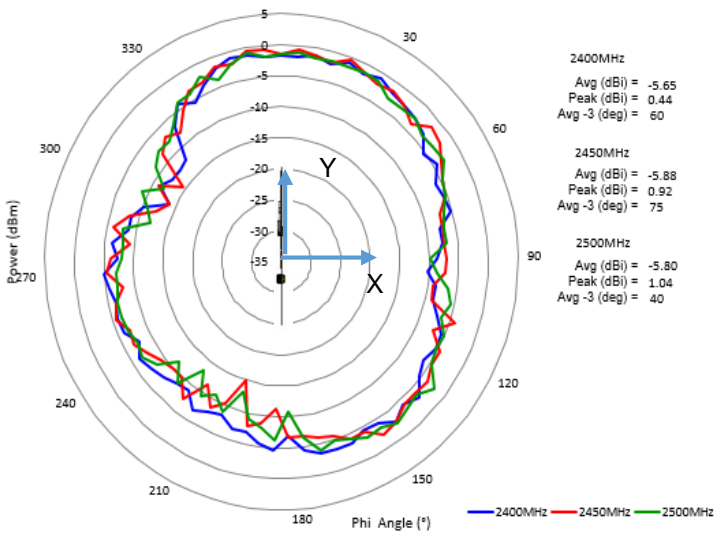

ZX plane

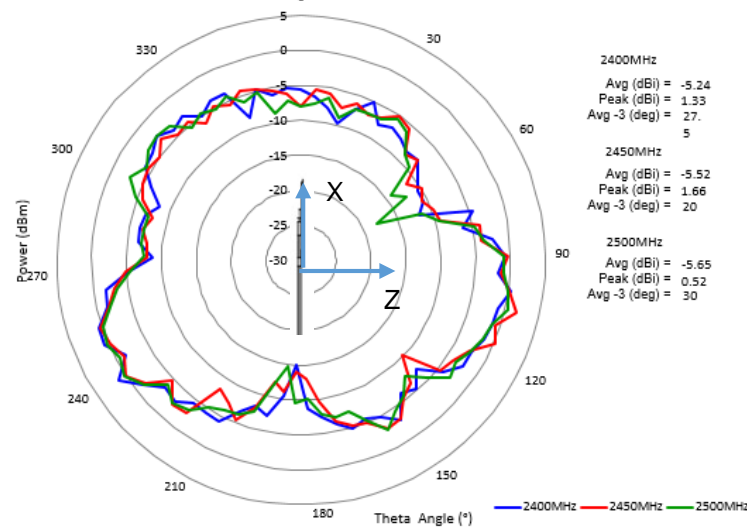

YZ plane

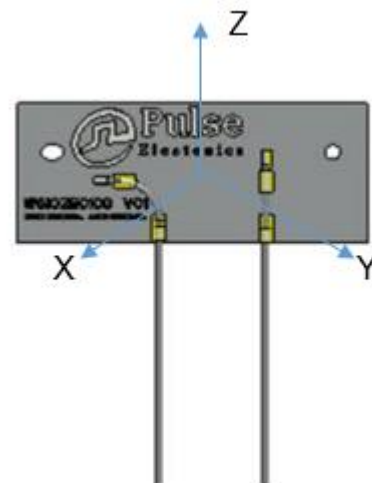
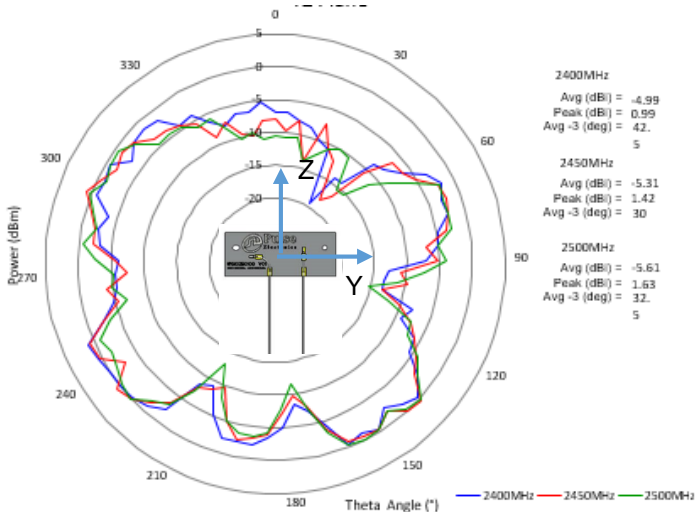

Issue: 1701

In the effort to improve our products, we reserve the right to make changes judged to be necessary.

CONFIDENTIAL AND PROPRIETARY INFORMATION

This document contains confidential and proprietary information of Pulse Electronics, Inc. (Pulse) and is protected by copyright, trade secret and other state and federal laws. Its receipt or possession does not convey any rights to reproduce, disclose its contents, or to manufacture, use or sell anything it may describe. Reproduction, disclosure or use without specific written authorization of Pulse is strictly forbidden.

Description: 2X2 MIMO Dual WiFi Antenna

Series: FPC Antenna

PART NUMBER: W6102B0100

CHARTS

Typical free space radiation pattern—Antenna2: 4.9-5.925GHz
 (*) All RF parameters measured on 2mm thick PC plate

XY plane

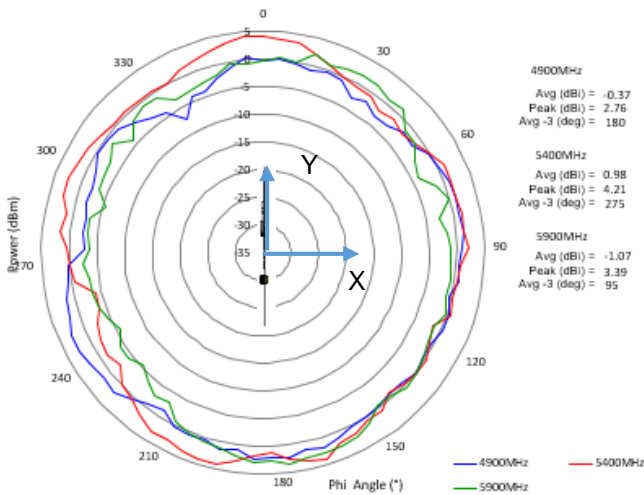

ZX plane

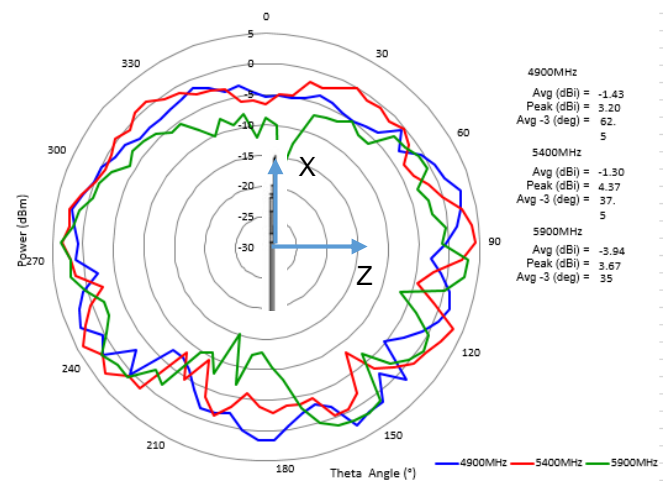

YZ plane

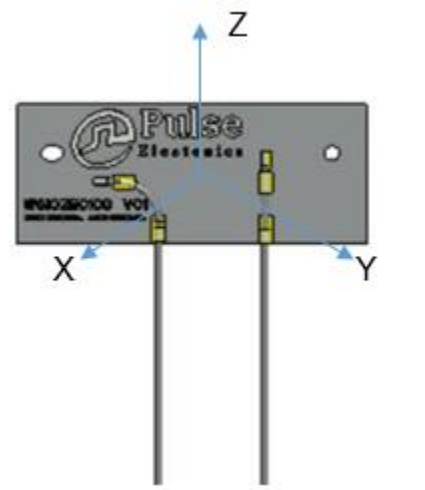
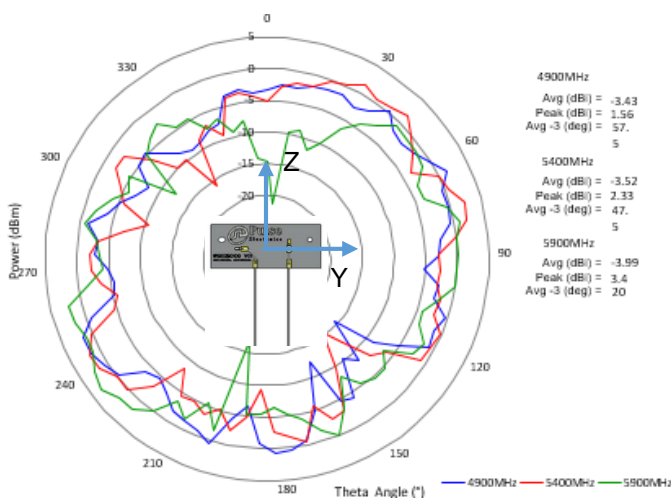

Issue: 1701

In the effort to improve our products, we reserve the right to make changes judged to be necessary.

CONFIDENTIAL AND PROPRIETARY INFORMATION

This document contains confidential and proprietary information of Pulse Electronics, Inc. (Pulse) and is protected by copyright, trade secret and other state and federal laws. Its receipt or possession does not convey any rights to reproduce, disclose its contents, or to manufacture, use or sell anything it may describe. Reproduction, disclosure or use without specific written authorization of Pulse is strictly forbidden.

Description: 2X2 MIMO Dual WiFi Antenna

Series: FPC Antenna

PART NUMBER: W6102B0100

PACKAGING

5 antennas packed in one plastic bag

100 bags(TBD) of antennas packed in a cardboard box

1 label on each box with qty, part number, date code.

Issue: 1701

In the effort to improve our products, we reserve the right to make changes judged to be necessary.

CONFIDENTIAL AND PROPRIETARY INFORMATION

This document contains confidential and proprietary information of Pulse Electronics, Inc. (Pulse) and is protected by copyright, trade secret and other state and federal laws. Its receipt or possession does not convey any rights to reproduce, disclose its contents, or to manufacture, use or sell anything it may describe. Reproduction, disclosure or use without specific written authorization of Pulse is strictly forbidden.