

MOX500 Series

Epoxy Molded, Metal Glaze-Metal Oxide Resistors



FEATURES

- Meets Mil-Std-202
- Meets IEC 61000-4-5 up to 2KV
- Molded Construction
- Available in E96 values

CHARACTERISTICS

Resistor Type	Thick Film, Epoxy Molded
Power Rating	2W at 70°C 3W at 25°C
Resistance Range	5% 100Ω - 5MΩ 100/200 ppm
Tolerance	2% 1.1KΩ - 5MΩ 100/200 ppm
Temp. Coeff. Resistance	1% 15Ω - 67KΩ 350 ppm
Max. Working Voltage	Not all tolerances and TCR values available throughout entire resistance range
Max. Working Voltage	RCWV or 1000 V whichever lesser. (RCWV = rated DC or RMS AC continuous working voltage at commercial line frequency and waveform (volt))
Diel. With-standing Volt.	1000 VRMS
Terminals	Copper Wire, Solder Coated axial, RoHS composition
Oper. Temp.	-55° to +155°C

Characteristic	Test Method	ΔR limits
Moisture Resistance	MIL-STD-202, Method 106G	±0.20%
Humidity	MIL-STD-202, Method 103, Condition B	±0.25%
Shock	MIL-STD-202, Method 213, Condition I	±0.10%
Vibration	MIL-STD-202, Method 204, Condition D	±0.10%
Terminal Strength	MIL-STD-202, Method 211A, Condition A or B	±0.10%
Short Term Overload	DC test potential 2.5 time the rated continuous working voltage but not exceeding twice the maximum voltage specified	±0.5%
Load Life	1000 hrs at RCWV duty cycle 1.5hr ON, 0.5 hr OFF at 70°C ±2°C	±2%
Temperature Cycling	-65° to +125°C	±0.10%
Resistance to soldering heat	Temp 350°C ±10°C for 3 ±0.5 sec	±1%

Derating

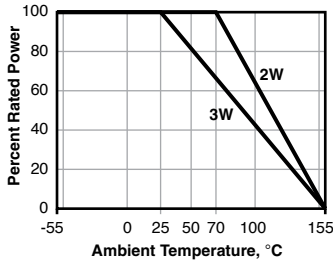

Single Impulse Test

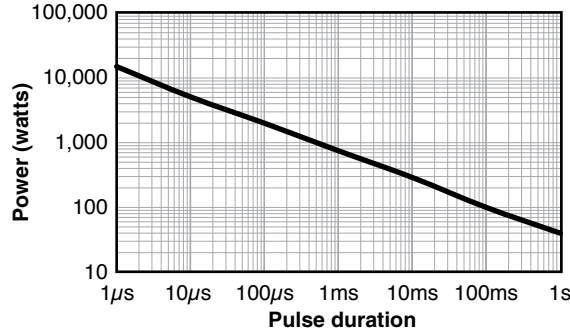

Surge Immunity Test

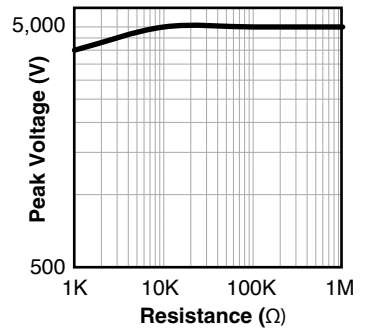

Resistors are tested in accordance with IEC61000-4-5, waveform 1.2/50μS, 10 Pulses applied. Limit of acceptance is a shift in resistance of less than 1% from the initial value.

DIMENSIONS

in./mm

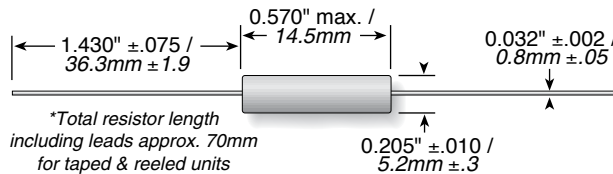

MOX500 Series

Epoxy Molded, Metal Glaze-Metal Oxide Resistors

TAPE & REEL

EIA-296 standard

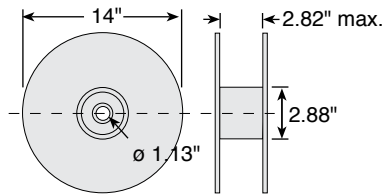
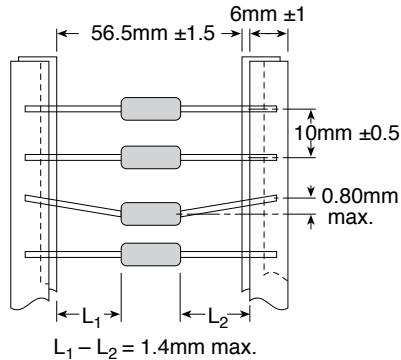

ORDERING INFORMATION

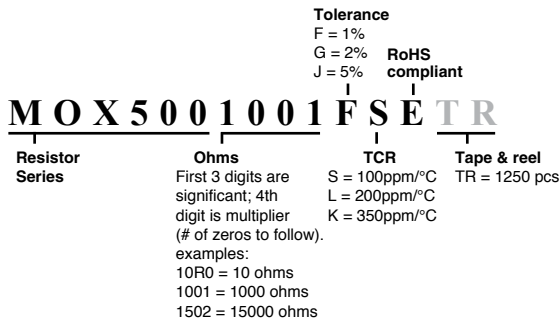

Standard part numbers for MOX500 Series

Resistance	2% tolerance	5% tolerance
100		MOX500100RJSE
150		MOX500150RJSE
270		MOX500270RJSE
1K		MOX5001001JSE
1.5K		MOX5001501JSE
2.7K	MOX5002701GSE	
3.3K		MOX5003301JSE
4.3K		MOX5004301JSE
6.8K		MOX5006801JSE
7.5K	MOX5007501GSE	
10K		MOX5001002JSE
15K		MOX5001502JSE
18K		MOX5001802JSE
20K	MOX5002002GSE	
27K	MOX5002702GSE	
33K		MOX5003302JSE
47K	MOX5004702GSE	
66K		MOX5006602JSE
100K	MOX5001003GSE	
150K	MOX5001503GSE	
220K	MOX5002203GSE	
270K	MOX5002703GSE	
330K	MOX5003303GSE	
1M	MOX5001004GSE	