

EC-E...

Electronic miniature circuit-breaker

CLIPLINE

Data sheet
103906_en_01

© PHOENIX CONTACT - 09/2009

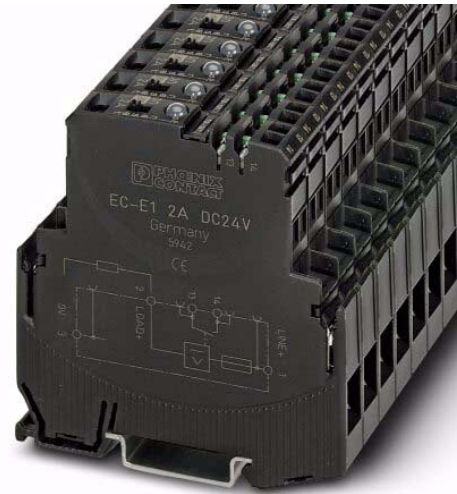

1 Description

The EC-E... electronic miniature circuit-breaker selectively protects all 24 V DC load circuits on power supply units. A combination of active electronic current limitation for short circuits and an overload shutdown function from $1.1 \times I_N$ upwards ensures that the miniature circuit-breaker can react to overloads faster than the power supply unit. In this case, the residual current is constantly restricted to 1.3 - 1.8 times the nominal current.

This enables capacitive loads of up to 20,000 μF to be switched on; loads are shut down only in the event of an overload or short circuit.

Once an overload or short circuit has been detected in the load circuit, the load output of the EC-E... is blocked. The current flow in the faulty circuit is interrupted. The EC-E... and, therefore, the current circuit can be activated again using the electronic reset input or manually on the device using the slide switch.

Wiring and signaling tasks can be implemented easily using power rails and plug-in bridges.

A multi-color LED and the integrated status output display the operating and fault state.

The miniature circuit-breaker has a design width of 12.5 mm and can be snapped onto NS 35 DIN rails using a modular approach. It is equipped with screw connections.

1.1 Properties

- Selective load protection, electronic shutdown characteristic curve
- Active current limitation when switching on capacitive loads of up to 20,000 μF and in the event of an overload/short circuit
- Nominal current can be selected in fixed current strengths from 0.5 A ... 12 A
- Safe overload shutdown from $1.1 \times I_N$ upwards, even with long load lines or small cable cross-sections
- Manual on/off switch (S1)
- Clear signaling by means of LED, SF status output, or F alarm output (signal contact), (can be combined)
- RE electronic reset input (option)
- Integrated fail-safe element, adapted to nominal current
- Straightforward wiring using LINE+ power rail and 0 V, as well as signal rails and signal bridges



NOTE: Make sure that you adapt the cable cross-section of the relevant load circuit to the nominal current of the EC-E... being used.

Take special precautions in the system or machine to eliminate the possibility of system parts restarting (in accordance with the Machinery Directive 2006/42/EC and EN 60204-1). In the event of a fault (short circuit/overload), the EC-E... shuts down the load circuit electronically.



Make sure you always use the latest documentation.
It can be downloaded at www.phoenixcontact.net/download.



This data sheet is valid for all products listed on the following page:

2 Ordering data

Electronic miniature circuit-breakers

Description	Nominal current	Type	Order No.	Pcs./Pkt.
Electronic miniature circuit-breaker with signal contact: 1 N/O contact	0.5 A	EC-E1 0.5 A	0903022	6
Electronic miniature circuit-breaker with signal contact: 1 N/O contact	1 A	EC-E1 1.0 A	0903023	6
Electronic miniature circuit-breaker with signal contact: 1 N/O contact	2 A	EC-E1 2.0 A	0903024	6
Electronic miniature circuit-breaker with signal contact: 1 N/O contact	3 A	EC-E1 3.0 A	0903025	6
Electronic miniature circuit-breaker with signal contact: 1 N/O contact	4 A	EC-E1 4.0 A	0903026	6
Electronic miniature circuit-breaker with signal contact: 1 N/O contact	6 A	EC-E1 6.0 A	0903028	6
Electronic miniature circuit-breaker with signal contact: 1 N/O contact	8 A	EC-E1 8.0 A	0903029	6
Electronic miniature circuit-breaker with signal contact: 1 N/O contact	10 A	EC-E1 10 A	0903030	6
Electronic miniature circuit-breaker with signal contact: 1 N/O contact	12 A	EC-E1 12 A	0903031	6
Electronic miniature circuit-breaker with signal contact: 1 N/C contact	0.5 A	EC-E4 0.5 A	0903040	6
Electronic miniature circuit-breaker with signal contact: 1 N/C contact	1 A	EC-E4 1.0 A	0903032	6
Electronic miniature circuit-breaker with signal contact: 1 N/C contact	2 A	EC-E4 2.0 A	0903033	6
Electronic miniature circuit-breaker with signal contact: 1 N/C contact	3 A	EC-E4 3.0 A	0903034	6
Electronic miniature circuit-breaker with signal contact: 1 N/C contact	4 A	EC-E4 4.0 A	0903035	6
Electronic miniature circuit-breaker with signal contact: 1 N/C contact	6 A	EC-E4 6.0 A	0903036	6
Electronic miniature circuit-breaker with signal contact: 1 N/C contact	8 A	EC-E4 8.0 A	0903037	6
Electronic miniature circuit-breaker with signal contact: 1 N/C contact	10 A	EC-E4 10 A	0903038	6
Electronic miniature circuit-breaker with signal contact: 1 N/C contact	12 A	EC-E4 12 A	0903039	6
Electronic miniature circuit-breaker with reset input and status output	0.5 A	EC-E 0.5 A 24 V DC	0903041	6
Electronic miniature circuit-breaker with reset input and status output	1 A	EC-E 1.0 A 24 V DC	0903042	6
Electronic miniature circuit-breaker with reset input and status output	2 A	EC-E 2.0 A 24 V DC	0903043	6
Electronic miniature circuit-breaker with reset input and status output	3 A	EC-E 3.0 A 24 V DC	0903044	6
Electronic miniature circuit-breaker with reset input and status output	4 A	EC-E 4.0 A 24 V DC	0903045	6
Electronic miniature circuit-breaker with reset input and status output	6 A	EC-E 6.0 A 24 V DC	0903046	6
Electronic miniature circuit-breaker with reset input and status output	8 A	EC-E 8.0 A 24 V DC	0903047	6
Electronic miniature circuit-breaker with reset input and status output	10 A	EC-E 10 A 24 V DC	0903048	6
Electronic miniature circuit-breaker with reset input and status output	12 A	EC-E 12 A 24 V DC	0903049	6

Version	Signal input	Signal output		
		F alarm output (signal contact)		SF status output
	RE +24 V reset input	Individual-signal N/O contact (normally open)	Individual-signal N/C contact (normally closed)	SF +24 V status output = OK
EC-E1	-	x	-	-
EC-E4	-	-	x	-
EC-E	x	-	-	x

Accessories

Description	Type	Order No.	Pcs./Pkt.	
Continuous plug-in bridge for LINE+ and 0 V, insulated with gray material, 500 mm long, can be cut to length Current carrying capacity with one supply: $I_{max} = 50$ A, (recommendation: central input) Current carrying capacity with two supplies: $I_{max} = 63$ A	Gray	FBST 500 TMC-NGY	0901028	10
Continuous plug-in bridge for signal contacts and reset inputs, insulated with gray material, 500 mm long, can be cut to length Current carrying capacity with one supply: $I_{max} = 1$ A With signal contacts connected in series: $I_{max} = 0.5$ A	Blue Red	FBST 500-PLC-BU FBST 500-PLC-RD	2966692 2966789	20 20
Zack marker strip, flat, 10-section		UC-TMF12	0819233	10
Screwdriver		SZS 0.6X3.5	1205053	10

3 Technical data



NOTE: Data apply where $T_A = 25^\circ\text{C}$ and $U_B = 24\text{ V DC}$.

Operating data

Nominal voltage U_B	24 V DC (18 V DC ... 32 V DC)
Nominal current I_N	Depending on product version selected: Fixed current strengths: 0.5 A, 1 A, 2 A, 3 A, 4 A, 6 A, 8 A, 10 A, 12 A
Closed-circuit current I_0	When ON: Typically 20 mA ... 30 mA, depending on signal output

Shutdown

Shutdown times	Refer to the time/current characteristic curve (see page 8)
Typical behavior	3 s where $I_{\text{load}} > 1.1 \times I_N$ 100 ms ... 3 s where $I_{\text{load}} > 1.8 \times I_N$ (or $1.5 \times I_N/1.3 \times I_N$)
EC-E4: Pin 11/12	Individual signaling (N/C contact)
EC-E1: Pin 13/14	Individual signaling (N/O contact)
EC-E: SF 23, RE 22	RE reset input, SF status output

Status indicators

Operating state signaling	<ul style="list-style-type: none"> - Multi-color LED - SF status output (option) - Floating signal contact (F alarm output) (option) - On/off setting for switch S1
Multi-color LED	<p>Green = Device switched on (S1 = ON) or load circuit/Power MOSFET forced to trip</p> <p>Orange = Overload or short circuit leading to electronic shutdown</p> <p>Red = Device shut down electronically, load circuit/Power MOSFET switched off, undervoltage ($U_B < 8\text{ V}$) or after switch-on up to end of switch-on delay time</p> <p>OFF: Manually switched off (S1 = OFF) or device voltage is disconnected</p>

Load circuit

Load output	Power MOSFET switching output (positive switching)
Overload shutdown (OL)	Typically $1.1 \times I_N$ (1.05 ... $1.35 \times I_N$)
Short-circuit current I_K	Active current limitation (see page 5)
Temperature shutdown	Internal temperature monitoring with electronic shutdown
Undervoltage monitoring for load output after each switch-on procedure	With hysteresis, no reset required: Load "OFF" at $U_B < 8\text{ V}$
Switch-on delay t_{start}	Typically 0.5 s after reset and after U_B applied
Load circuit shutdown	Electronic shutdown after overload/short circuit
Free running circuit	External free-wheeling diode recommended for inductive load
Parallel connection of multiple load outputs	Not permitted

F alarm output, signal contact (for EC-E1 and EC-E4 only)

Electrical data	Floating signal contact 30 V DC/0.5 A maximum, 10 V/10 mA minimum
Normal state, LED lights up green	U_B is present, switch S1 is set to ON, and no overloads or short circuits occur
OFF state, LED off	<ul style="list-style-type: none"> - Device switched off (switch S1 set to OFF) - Operating voltage U_B is not present

F alarm output, signal contact (for EC-E1 and EC-E4 only) (continued)

Fault state, LED lights up orange	Overload condition $> 1.1 \times I_N$ leading to electronic shutdown
Fault state, LED lights up red	<ul style="list-style-type: none"> – Electronic shutdown after overload or short circuit – Device switched off with control signal (switch S1 set to ON) – EC-E1: Individual signal, N/O contact open, pins 13 and 14 – EC-E4: Individual signal, N/C contact closed, pins 11 and 12
Fault description	<p>F alarm output (signal contact) is in a fault state if</p> <ul style="list-style-type: none"> – Operating voltage U_B is not present – ON/OFF switch S1 is set to OFF – The LED lights up red (electronic shutdown)

Status output (for EC-E only)

Electrical data	<p>Positive-switching signal output, switches U_B to pin 23, nominal data: 24 V DC/0.2 A maximum (short-circuit-proof).</p> <p>The status output is terminated internally to 0 V with a 10-kohm resistance.</p>
OUT status	<p>EC-E... (OUT signal status), where $U_B = +24$ V</p> <p>+24 V = S1 is ON, load output forced to trip</p> <p>0 V = S1 is ON, load output blocked, and/or switch S1 is OFF.</p> <p>LED lights up red</p>
OFF state	<p>0 V level at status output in all cases where:</p> <ul style="list-style-type: none"> – Switch S1 is set to ON, but the device is still subject to a switch-on delay – Switch S1 is set to OFF or control signal OFF, device is switched off – Operating voltage U_B is not present

Reset input (for EC-E only)

Electrical data	<p>Maximum voltage: +32 V DC</p> <p>High > 8 V DC ≤ 32 V DC</p> <p>Low ≤ 3 V DC > 0 V DC</p> <p>Current consumption: Typ. 2.6 mA (+24 V DC)</p> <p>Minimum pulse duration: 10 ms</p>
RE reset signal, pin 22	<p>When the EC-E is electronically blocked, it can be switched on again remotely on the falling edge of a +24 V DC pulse, using an external button. A common reset signal can also be applied to several devices at the same time. Devices that are switched on remain unaffected by this.</p>

Connection terminal blocks

LINE+/LOAD+/0 V connection terminal blocks

Screw connections	M4		
Connection capacity	Solid	Stranded	With ferrule
1 conductor	0.5 mm ² ... 10 mm ²	0.5 mm ² ... 10 mm ²	0.5 mm ² ... 10 mm ²
2 conductors (two conductors with the same cross-section)	0.5 mm ² ... 4 mm ²	0.5 mm ² ... 4 mm ²	0.5 mm ² ... 2.5 mm ²
2 stranded conductors with a TWIN ferrule		0.5 mm ² ... 6 mm ²	
Stripping length	10 mm		
Torque (EN 60934)	1.5 Nm ... 1.8 Nm		

Signal connections for connection terminal blocks

Screw connections	M3
Stranded connection capacity with ferrule	0.25 mm ² ... 2.5 mm ²
Stripping length	8 mm
Torque (EN 60934)	0.5 Nm

General data

Fail-safe element	No backup fuse required for EC-E... as a redundant fail-safe element is integrated (fuse element)
Mounting the housing	DIN rail in acc. with EN 50022, NS 35 x 7.5
Ambient temperature (operation)	0°C ... +50°C (without condensation, see EN 60204-1)
Ambient temperature (storage)	-20°C ... +70°C
Humid heat	96 h, 95% relative humidity, 40°C in acc. with IEC 60068-2-78, Test Cab. Climatic class 3K3 according to EN 60721
Degree of protection (housing, terminals)	IP20, DIN 40050
Installation dimensions (W x H x D)	12.5 mm x 80 mm x 83 mm
Weight	Approx. 65 g

Tests/approvals

Conformance with EMC Directive 2004/108/EC	Noise emission: EN 61000-6-3 Noise immunity: EN 61000-6-2
Insulation coordination (IEC 60934)	0.5 kV/pollution degree 2, increased insulation in actuation area
Dielectric strength	32 V DC maximum (load circuit)
Insulation resistance ("off" state)	None, electronic shutdown only
Vibration resistance	3g, tested in acc. with IEC 60068-2-6, test Fc
Approvals	UL 2367, File E317172 Solid State Overcurrent Protectors UL 1604, File E324415 (class I, division 2, groups A, B, C, D) CE

Voltage drop, current limitation, maximum load current

Nominal current I_N	Typical voltage drop U_{ON} at I_N	Active current limitation (typical)	Max. load current at 100% OT, $T_A = 40^\circ\text{C}$	Max. load current at 100% OT, $T_A = 50^\circ\text{C}$
0.5 A	70 mV	$1.8 \times I_N$	0.5 A	0.5 A
1 A	80 mV	$1.8 \times I_N$	1 A	1 A
2 A	130 mV	$1.8 \times I_N$	2 A	2 A
3 A	80 mV	$1.8 \times I_N$	3 A	3 A
4 A	100 mV	$1.8 \times I_N$	4 A	4 A
6 A	130 mV	$1.8 \times I_N$	6 A	5 A
8 A	120 mV	$1.5 \times I_N$	8 A	7 A
10 A	150 mV	$1.5 \times I_N$	10 A	9 A
12 A	180 mV	$1.3 \times I_N$	12 A	10.8 A



In cases where a row-mounting configuration is being used without convection cooling, the effect of the heat during continuous operation (100% OT) means that the nominal device current may only be run at a maximum of 80% of its strength.

3.1 Connection diagrams



The signal contacts are shown in an off state or fault state.

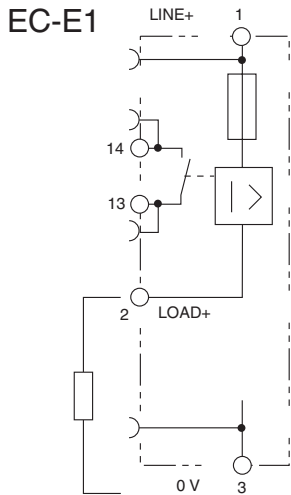

Without signal input, with F alarm output (individual signal, N/O contact)

Normal state: 13 - 14 closed
Fault state: 13 - 14 open

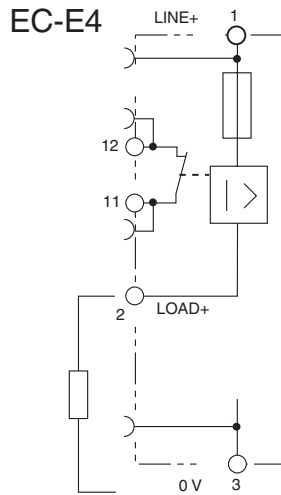

Without signal input, with F alarm output (individual signal, N/C contact)

Normal state: 11 - 12 open
Fault state: 11 - 12 closed

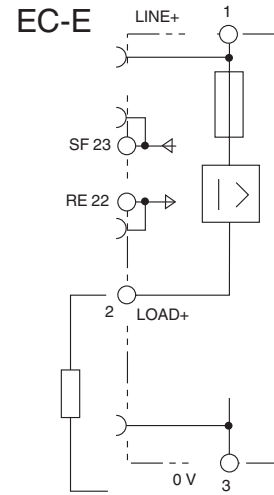

With RE reset input (+24 V DC), with SF status output (+24 V = load output ON)

Normal state: SF +24 V = OK
Fault state: SF 0 V

Figure 1 Signal inputs/outputs

3.2 Block diagram (using example of EC-E)

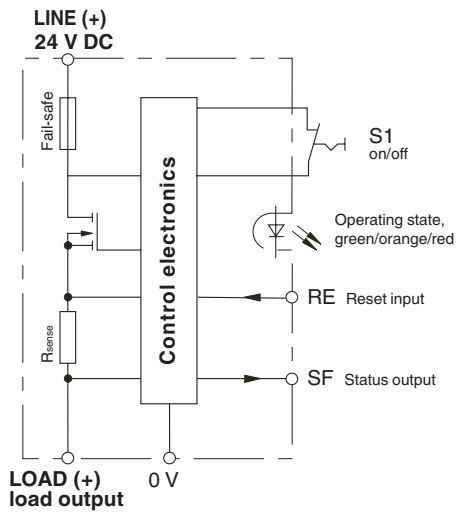

Figure 2 Block diagram (using example of EC-E)

3.3 Information on UL approval



File E324415

Operating Temperature Code T5

- This equipment is suitable for use in Class I, Division 2, Groups A, B, C and D or non-hazardous locations only

WARNING:

- Exposure to some chemicals may degrade the sealing properties of materials used in the following device:

Relay

Sealant material:

- Generic name: Modified diglycidyl ether of bisphenol A
- Supplier: Fine Polymers Corporation
- Type: Epi Fine 4616L-160PK

Casing material:

- Generic name: Liquid crystal polymer
- Supplier: Sumitomo Chemical
- Type: E4008, E4009, or E6008

RECOMMENDATION:

- Periodically inspect the device named above for any degradation of properties and replace if degradation is found

WARNING – EXPLOSION HAZARD:

- Do not disconnect equipment unless power has been removed or the area is known to be non-hazardous
- Substitution of any components may impair suitability for Class I, Division 2



Non-hazardous use - UL File E317172

Class 2

Meets requirement for Class 2 current limitation (EC-E...-0.5 A/1 A/2 A/3 A)

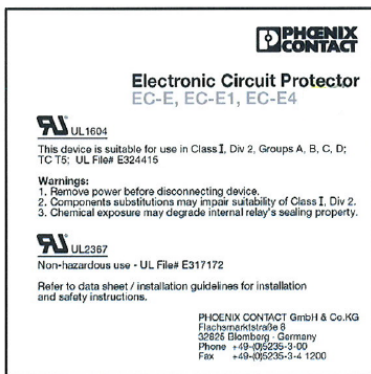

Figure 3 UL approval package slip

3.4 Dimensions

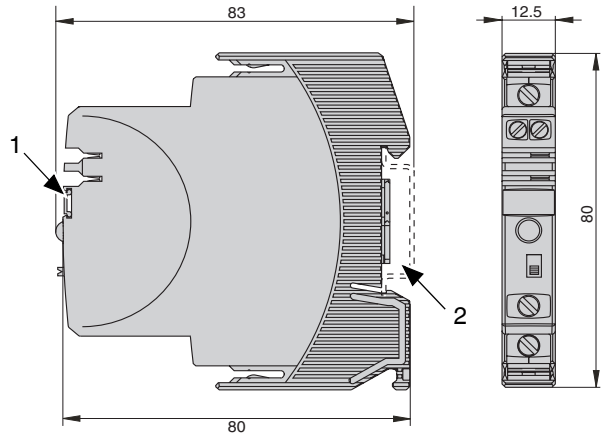

Figure 4 Dimensions in mm

- 1 UC-TMF 12 marking label
- 2 Snap-on socket for DIN rail in acc. with EN 50022, NS 35 x 7.5

3.5 Structure



Figure 5 Structure (using example of EC-E1)

- 1 Line+ power rail
- 2 0-V power rail
- 3 Signal rail or signal bridge
- 4 Shock protection slides (molded below the housing and can be easily removed)

3.6 Time/current characteristic curve ($T_A = 25^\circ\text{C}$)

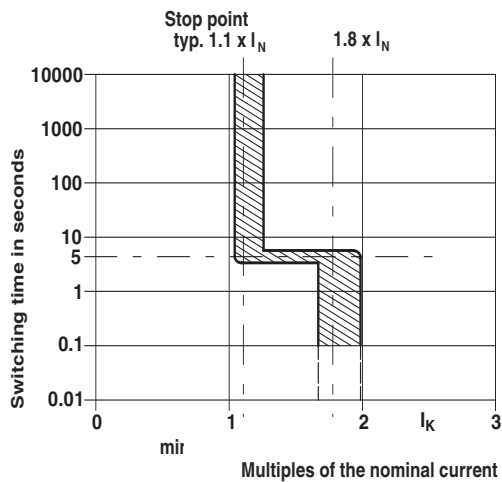

Figure 6 Time/current characteristic curve

- In the $1.1 \dots 1.8 \times I_N^*$ range, the shutdown time is typically 3 s.
 - The electronic current limitation function is typically used from $1.8 \times I_N^*$ upwards.
This means that, typically, 1.8 times the nominal current* is flowing in the case of all overload conditions that lead to a shutdown (regardless of the power supply and load circuit resistance). The shutdown time ranges from 100 ms to 3 s depending on the multiple of the nominal current, or in the event of a short circuit (I_K).
 - Without the current limitation function used at, typically, $1.8 \times I_N^*$, a considerably higher overcurrent would flow in the event of an overload or a short circuit.
- * Current limitation typically $1.8 \times I_N$ where $I_N = 0.5 \text{ A} \dots 6 \text{ A}$
 Current limitation typically $1.5 \times I_N$ where $I_N = 8 \text{ A}$ or 10 A
 Current limitation typically $1.3 \times I_N$ where $I_N = 12 \text{ A}$

3.7 Safe shutdown

Safe shutdown of the EC-E... with different supply line lengths and cable cross-sections								
Specific electrical resistance for electrolytic copper: $\rho_0 = 0.0178 (\Omega \times \text{mm}^2)/\text{m}$								
$U_B = 19.2 \text{ V DC}$ (80% of 24 V DC)			The voltage drop on the EC-E... and the tolerance of the shutdown point (typically $1.1 \times I_N = 1.05 \dots 1.35 \times I_N$) have already been taken into account.					
EC-E... nominal current setting I_N (in A) →			3 A		6 A		→ EC-E... typically shuts down after 3 s	
E.g., shutdown current $I_{\text{shut}} = 1.25 \text{ A} \times I_N$ (in A) →			3.75 A		7.5 A			
R_{max} in ohms = $(U_B/I_{\text{shut}}) - 0.050 \Omega^*$ →			5.07 Ω		2.51 Ω			
EC-E... trips safely from 0 Ω up to max. circuit resistance R_{max}								
Cable cross-section A in mm^2 →		0.14 mm^2	0.25 mm^2	0.34 mm^2	0.5 mm^2	0.75 mm^2	1 mm^2	1.5 mm^2
Length L in meters (= single length) ↓		Total cable resistance in ohms = $(R_0 \times 2 \times L)/A$						
		↓	↓	↓	↓	↓	↓	↓
5 m		1.27 Ω	0.71 Ω	0.52 Ω	0.36 Ω	0.24 Ω	0.18 Ω	0.12 Ω
10 m		2.54 Ω	1.42 Ω	1.05 Ω	0.71 Ω	0.47 Ω	0.36 Ω	0.24 Ω
15 m		3.81 Ω	2.14 Ω	1.57 Ω	1.07 Ω	0.71 Ω	0.53 Ω	0.36 Ω
20 m		5.09 Ω	2.85 Ω	2.09 Ω	1.42 Ω	0.95 Ω	0.71 Ω	0.47 Ω
25 m		6.36 Ω	3.56 Ω	2.62 Ω	1.78 Ω	1.19 Ω	0.89 Ω	0.59 Ω
30 m		7.63 Ω	4.27 Ω	3.14 Ω	2.14 Ω	1.42 Ω	1.07 Ω	0.71 Ω
35 m		8.90 Ω	4.98 Ω	3.66 Ω	2.49 Ω	1.66 Ω	1.25 Ω	0.83 Ω
40 m		10.17 Ω	5.70 Ω	4.19 Ω	2.85 Ω	1.90 Ω	1.42 Ω	0.95 Ω
45 m		11.44 Ω	6.41 Ω	4.71 Ω	3.20 Ω	2.14 Ω	1.60 Ω	1.07 Ω
50 m		12.71 Ω	7.12 Ω	5.24 Ω	3.56 Ω	2.37 Ω	1.78 Ω	1.19 Ω
75 m		19.07 Ω	10.68 Ω	7.85 Ω	5.34 Ω	3.56 Ω	2.67 Ω	1.78 Ω
100 m		25.34 Ω	14.24 Ω	10.47 Ω	7.12 Ω	4.75 Ω	3.56 Ω	2.37 Ω
125 m		31.79 Ω	17.80 Ω	13.09 Ω	8.90 Ω	5.93 Ω	4.45 Ω	2.97 Ω
150 m		38.14 Ω	21.36 Ω	15.71 Ω	10.68 Ω	7.12 Ω	5.34 Ω	3.56 Ω
175 m		44.50 Ω	24.92 Ω	18.32 Ω	12.46 Ω	8.31 Ω	6.23 Ω	4.15 Ω
200 m		50.86 Ω	28.48 Ω	20.94 Ω	14.24 Ω	9.49 Ω	7.12 Ω	4.75 Ω
225 m		57.21 Ω	32.04 Ω	23.56 Ω	16.02 Ω	10.68 Ω	8.01 Ω	5.34 Ω
250 m		63.57 Ω	35.60 Ω	26.18 Ω	17.80 Ω	11.87 Ω	8.90 Ω	5.93 Ω
Example 1: Max. permissible length at 1.5 mm^2 and 3 A →				Approx. 200 m[†]				
Example 2: Max. permissible length at 1.5 mm^2 and 6 A →				Approx. 100 m				
Example 3: Mixed wiring: (control cabinet--- sensor/actuator level)				R1 = 40 m in 1.5 mm^2 and R2 = 5 m in 0.25 mm^2 R1 = 0.95 ohms, R2 = 0.71 ohms Total (R1 + R2) = 1.66 ohms				

* Internal resistance of miniature circuit-breakers

† Shutdown current $I_{\text{shut}} = 3 \text{ A} \times 1.25 \text{ A} = 3.75 \text{ A}$
 Max. current resistance $R_{\text{max}} = U_B/I_{\text{shut}} - 0.050 \Omega$ (internal resistance of miniature circuit-breakers)
 $R_{\text{max}} = (19.2 \text{ V}/3.75 \text{ A}) - 0.050 \Omega = 5.07 \Omega$
 The value calculated, 5.07 Ω , falls between 200 m and 225 m in the table (4.75 Ω and 5.34 Ω).
 This means that you can bridge 200 m comfortably.

4 Mounting the potential distribution system

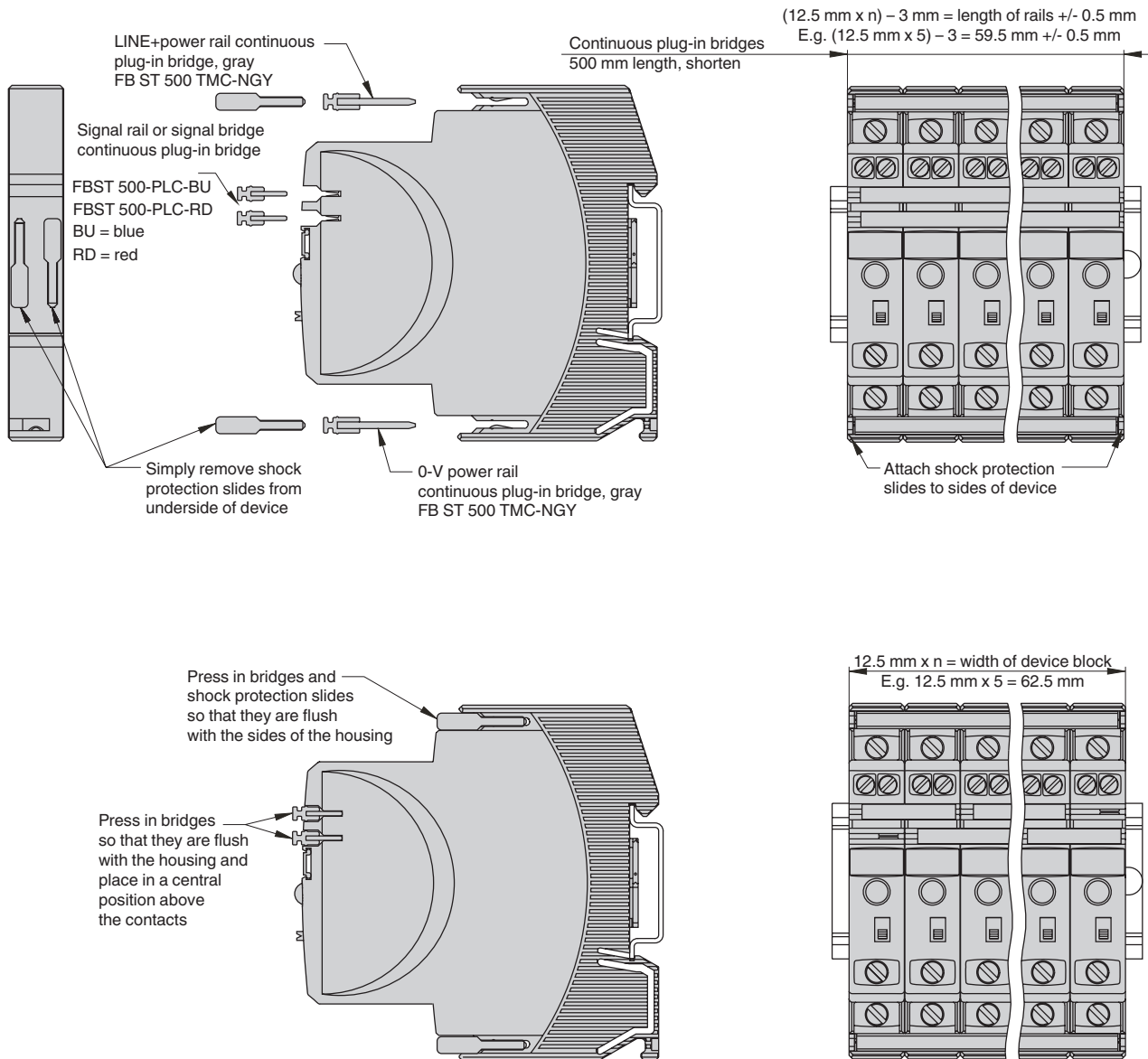

Figure 7 Mounting

A potential distribution system is integrated into the EC-E... Various continuous plug-in bridges can be used to create the following wiring configurations:

- LINE +(24 V DC)
- 0 V
- Signal contacts
- Reset inputs



NOTE: The EC-E... electronic miniature circuit-breakers require a 0-V connection.

5 Application examples



The signal contacts are shown in an off state or fault state.

5.1 EC-E1- group signaling (series connection)

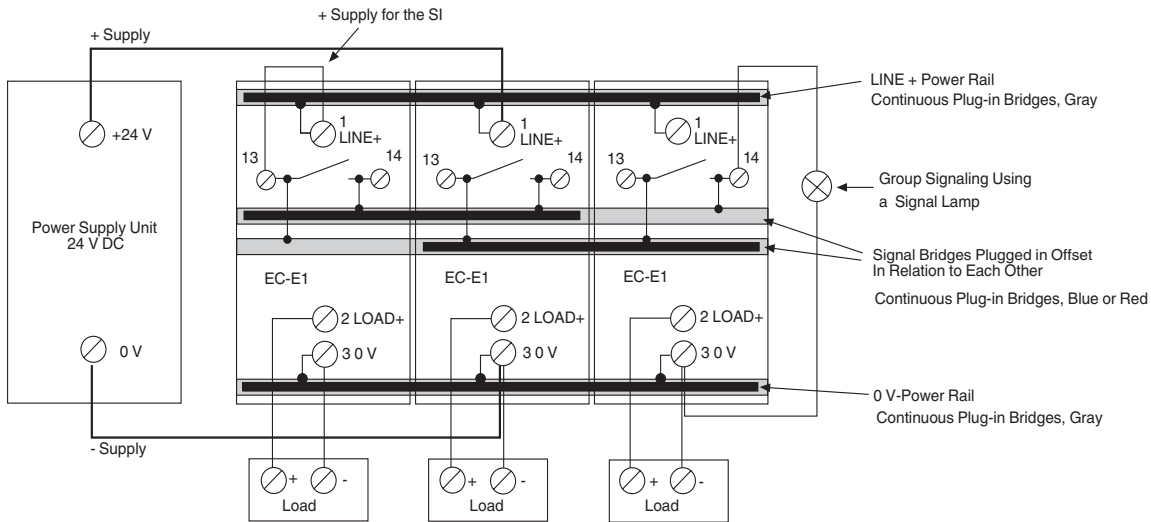

Figure 8 EC-E1- group signaling (series connection)

5.2 EC-E4 - individual signaling with common supply

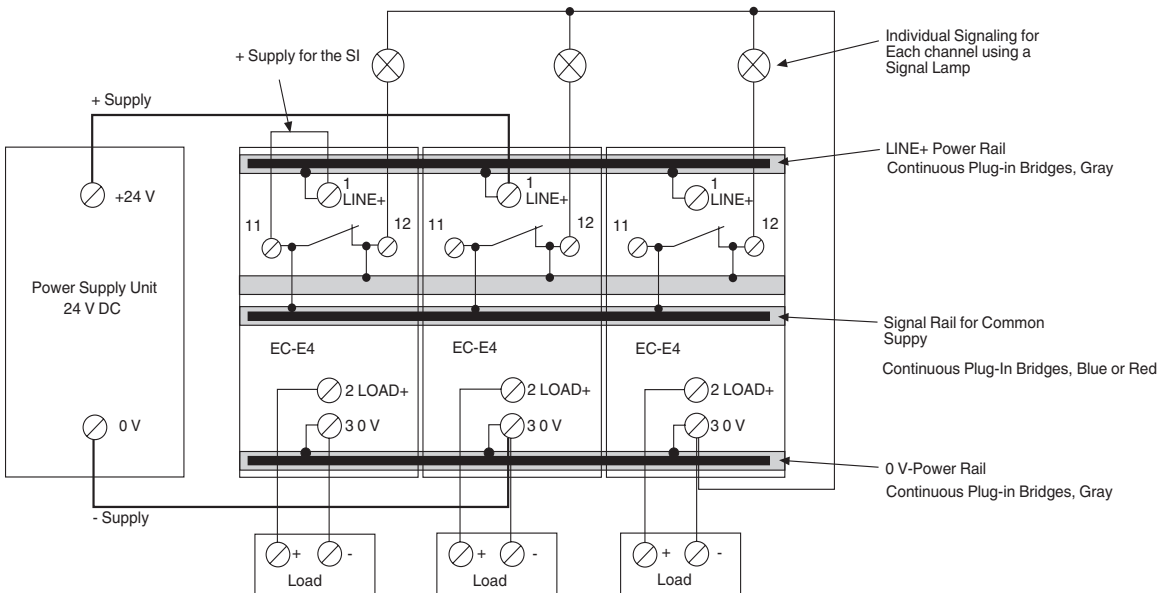

Figure 9 EC-E4 - individual signaling with common supply

5.3 EC-E – individual signaling with common reset

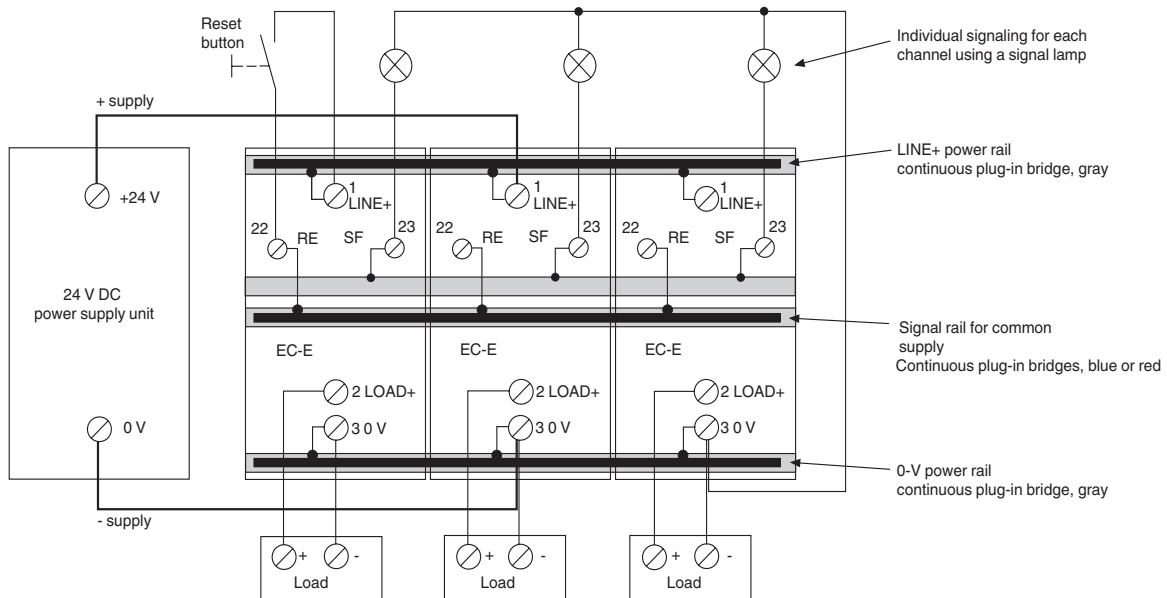

Figure 10 EC-E – individual signaling with common reset