

## CBT-90-UV-405 LEDs



### Table of Contents

Technology Overview .....2

Optical & Electrical Characteristics .....3

Flux & Spectral Characteristics vs. Temperature .....4

Lifetime & Power Maintenance.....5

Radiation Patterns .....6

Thermal Resistance .....6

Mechanical Dimensions ....7

Ordering Information .....8

### Features:

- >6.5 W of optical power from 400 nm to 410 nm.
- High thermal conductivity package .
  - › Junction to heat sink thermal resistance of 0.9 °C/W
- Photonic lattice technology for very high power density and uniform emission
- Large, monolithic chip with surface emitting area of 9 mm<sup>2</sup>
- Low-profile window for efficient coupling into small-etendue systems
- High radiometric efficiency
- Environmentally friendly: RoHS compliant, mercury-free
- Variable drive currents: less than 1 A through 22.5 A

### Applications

- Spot-curing
- Inspection
- Machine Vision
- Fiber-coupled illumination
- Rapid Prototyping and 3D printing
- Medical and Scientific Instrumentation

## Technology Overview

Luminus Big Chip LEDs™ benefit from innovations in device technology, chip packaging and thermal management. This suite of technologies give engineers and system designers the freedom to develop solutions both high in power and efficiency.

### Photonic Lattice Technology

Luminus' photonic lattice technology enables large area LED chips to emit photons uniformly over the entire LED chip surface. The intense optical power density produced by these UV Big Chip LEDs™ facilitate designs which replace arc and halogen lamps where arrays of traditional high power LEDs cannot.

For UV devices, Luminus engineers the photonic lattice to maximize light extraction and to emit with a Lambertian far-field distribution pattern. The design maximizes efficiency and allows for flexible optical designs.

### Packaging Technology

Thermal management is critical in high power LED applications. With a thermal resistance from junction to heat sink of 0.9°C/W, Luminus CBT-90-UV LEDs have the lowest thermal resistance of any LED on the market. This allows the LED to be driven at higher current densities while maintaining a low junction temperature, thereby resulting in brighter solutions and longer lifetimes.

### Reliability

Designed from the ground up, Luminus Big Chip LEDs are one of the most reliable light sources in the world today. Big Chip LEDs have passed a rigorous suite of environmental and mechanical stress tests, including mechanical shock, vibration, temperature cycling and humidity, and have been fully qualified for use in extreme high power and high current applications. With very low failure rates and median lifetimes that typically exceed 10,000 hours, Luminus Big Chip LEDs are ready for even the most demanding applications.

### Environmental Benefits

Luminus LEDs help reduce power consumption and the amount of hazardous waste entering the environment. All Big Chip LED products manufactured by Luminus are RoHS compliant and free of hazardous materials, including lead and mercury.

## Understanding Big Chip LED Test Specifications

Every Luminus LED is fully tested to ensure that it meets the high quality standards expected from Luminus' products.

### Testing Temperature

Luminus core board products are typically measured in such a way that the characteristics reported agree with how the devices will actually perform when incorporated into a system. This measurement is accomplished by mounting the devices on a 40°C heat sink and allowing the device to reach thermal equilibrium while fully powered. Only after the device reaches equilibrium are the measurements taken. This method of measurement ensures that Luminus Big Chip LEDs perform in the field just as they are specified.

### Multiple Operating Points (1 A, 9 A, 13.5 A)

The tables on the following pages provide typical optical and electrical characteristics. Since the LEDs can be operated over a wide range of drive conditions (currents from <1A to 22.5 A, and duty cycle from <1% to 100%), multiple drive conditions are listed.

CBT-90-UV devices are production specified at 9 A and 13.5 A. Driving devices beyond recommended driving conditions shortens lifetime (see derating curves on page 5).

**Reference Optical & Electrical Characteristics ( $T_{hs} = 40^{\circ}\text{C}$ )<sup>1,2</sup>**

UV					
Drive Condition		1 A	9 A	13.5 A	
Parameter	Symbol	Values <sup>4</sup>			Unit
Current Density	J	0.1	1.0	1.5	A/mm <sup>2</sup>
Forward Voltage	$V_{F\min}$		3.2		V
	$V_F$	3.2	3.7	3.9	V
	$V_{F\max}$		4.2		V
Radiometric Flux <sup>5</sup>	$\Phi_{\text{typ}}$	0.55	4.7	6.8	W
Radiometric Flux Density	$\Phi_R$	0.06	0.52	0.72	W/mm <sup>2</sup>
Wavelength Range	$\lambda$	399 - 409	400 - 410	401 - 411	nm
Peak Wavelength	$\lambda_p$	404	405	406	nm
FWHM	$\Delta\lambda_{1/2}$	12	13	14	nm

	Symbol	UV	Unit
Emitting Area		9	mm <sup>2</sup>
Emitting Area Dimensions		3 × 3	mm × mm
Dynamic Resistance	$\Omega_{\text{dyn}}$	0.02	$\Omega$

**Absolute Maximum Ratings**

	Symbol	UV	Unit
Maximum Current <sup>6</sup>		22.5	A
Maximum Junction Temperature <sup>7</sup>	$T_{j\max}$	150	°C
Storage Temperature Range		-40 to +100	°C

Note 1: Data verification pending NIST calibration.

Note 2: All data are based on test conditions with a constant heat sink temperature  $T_{hs} = 40^{\circ}\text{C}$  under pulse testing conditions. Listed drive conditions are typical for common applications. CBT-90-UV devices can be driven at currents ranging from <1 A to 22.5 A and at duty cycles ranging from 1% to 100%. Drive current and duty cycle should be adjusted as necessary to maintain the junction temperature desired to meet application lifetime requirements. See Thermal Resistance section for  $T_j$  and  $T_{hs}$  definition.

Note 3: reserved

Note 4: Unless otherwise noted, values listed are typical. Devices are production tested and specified at 9 A.

Note 5: Total flux from emitting area at listed peak wavelength. Reported performance is included to show trends for a selected power level. For specific minimum and maximum values, use bin tables. For product roadmap and future performance of devices, contact Luminus.

Note 6: CBT-90-UV LEDs are designed for operation to an absolute maximum current as specified above. Product lifetime data is specified at recommended forward drive currents. Sustained operation at or beyond absolute maximum currents will result in a reduction of device life time compared to recommended forward drive currents. Actual device lifetimes will also depend on junction temperature. Refer to the lifetime derating curves for further information. In pulsed operation, rise time from 10-90% of forward current should be longer than 0.5 microseconds.

Note 7: Lifetime dependent on LED junction temperature. Input power and thermal system must be properly managed to ensure lifetime. See charts on page 5 for further information.

Note 8: Special design considerations must be observed for operation under 1 A. Please contact Luminus for further information.

Note 9: Caution must be taken not to stare at the light emitted from these LEDs. Under special circumstances, the high intensity could damage the eye.



## Optical Power Characteristics

Relative Power vs Forward Current ( $I_f$ )  
Normalized to 13.5 A

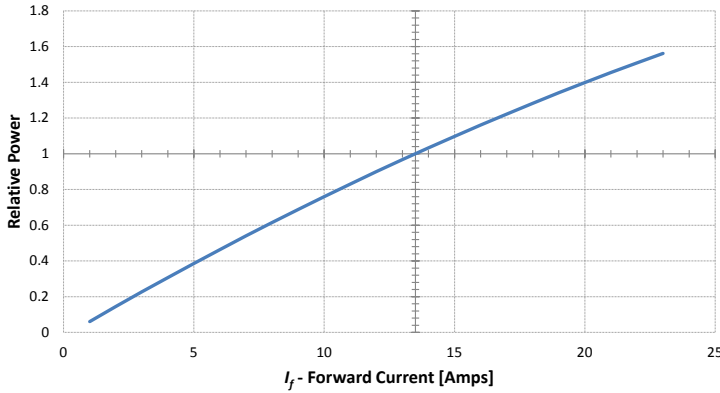

Relative Power vs Junction Temperature ( $T_j$ )  
Normalized to 80°C

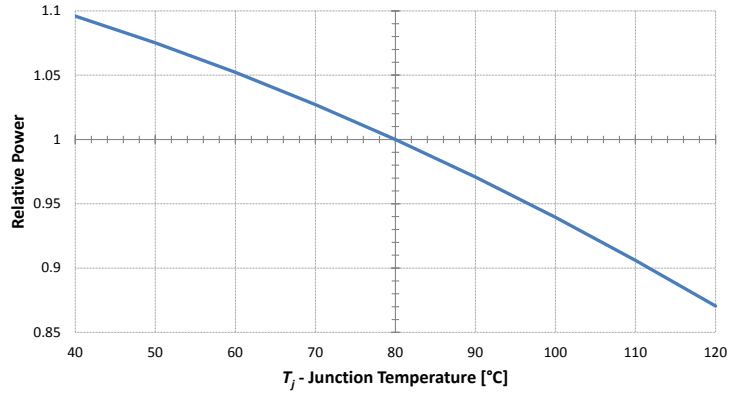

## Forward Voltage Characteristics

Change in Forward Voltage ( $V_f$ ) vs Forward Current ( $I_f$ )  
Referenced to 13.5 A

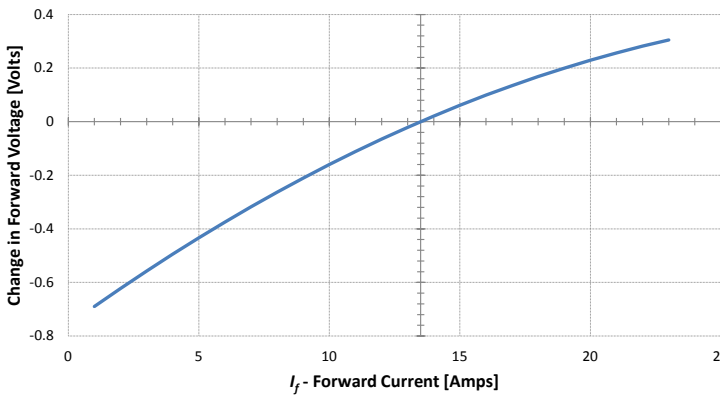

Change in Forward Voltage ( $V_f$ ) vs Junction Temperature ( $T_j$ )  
Referenced to 80°C

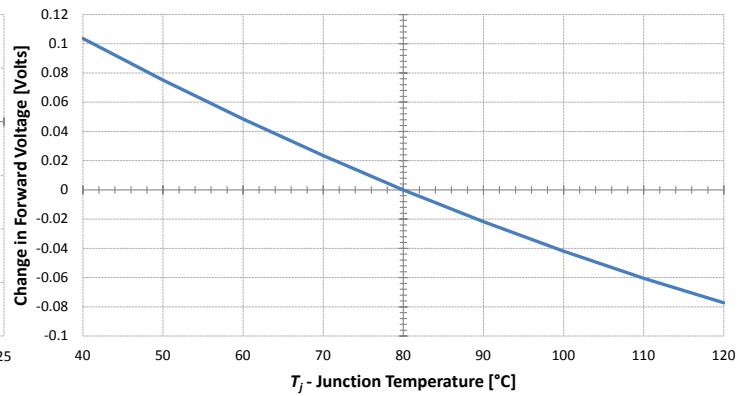

## Peak Wavelength Characteristics

Change in Peak Wavelength ( $\lambda_p$ ) vs Forward Current ( $I_f$ )  
Referenced to 13.5 A

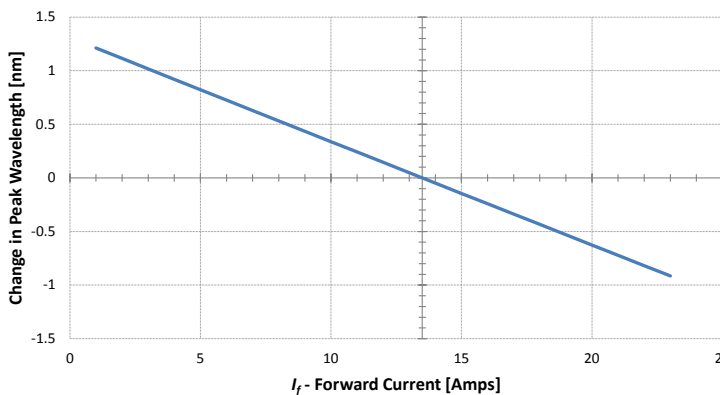

Change in Peak Wavelength ( $\lambda_p$ ) vs Temperature ( $T_j$ )  
Referenced to 80°C

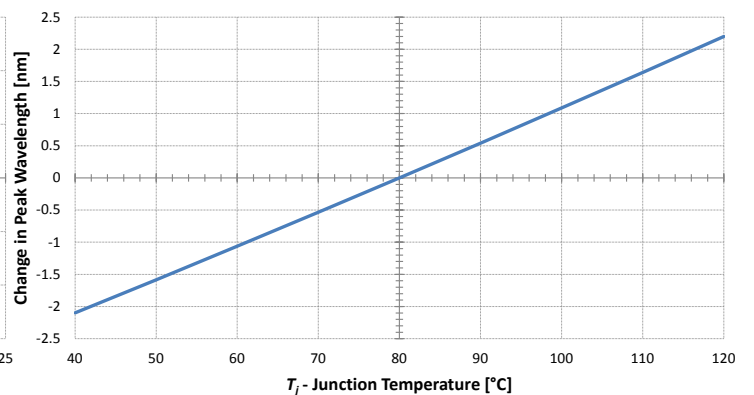

### CBT-90-UV B50 Reliability<sup>11</sup>

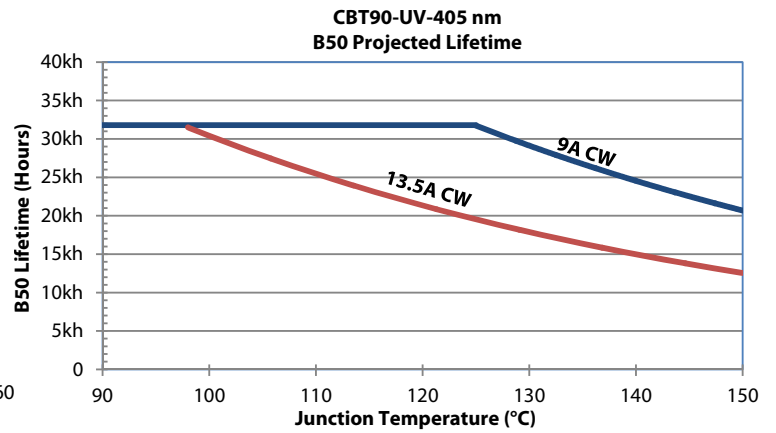
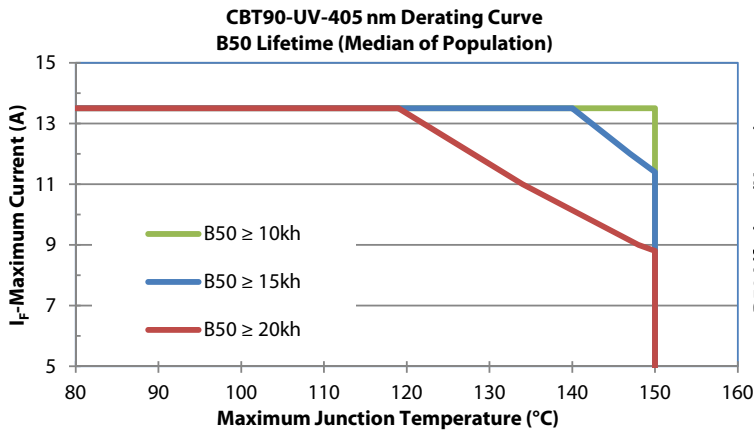

### CBT-90-UV B10 Reliability<sup>11</sup>

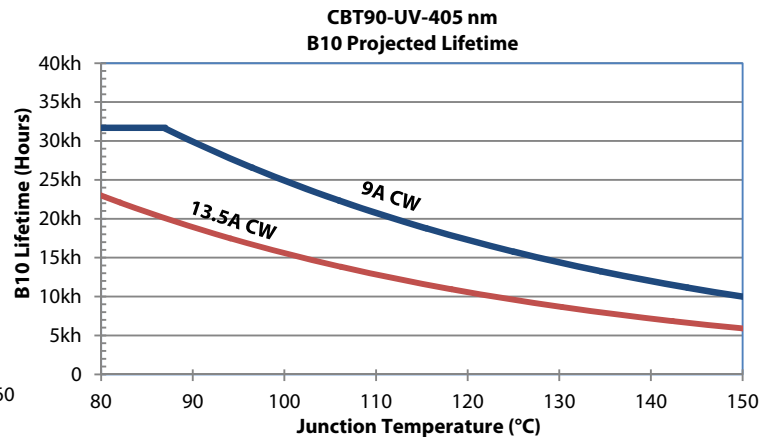
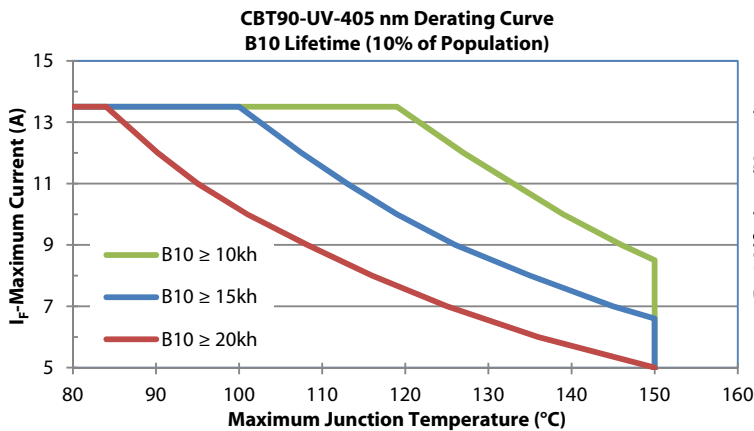

Note 11. Lifetime defined as time to 70% of initial intensity. Based on preliminary lifetime test data. Data can be used to model failure rate over typical product lifetime.

## Typical Radiation Pattern

Typical Angular Radiation Pattern

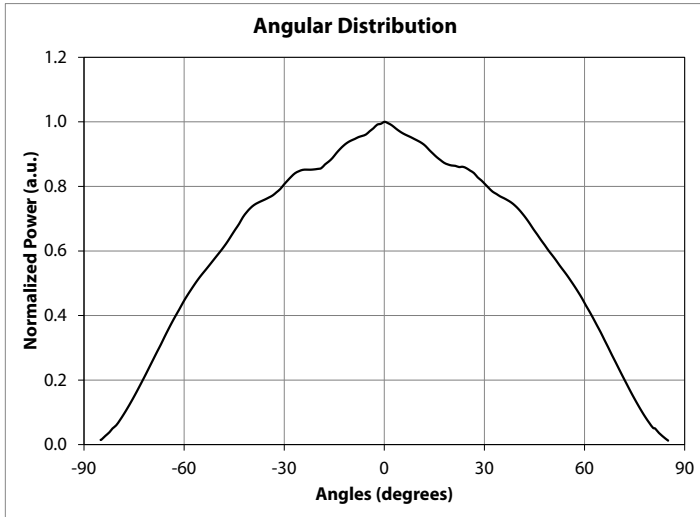

Typical Polar Radiation Pattern

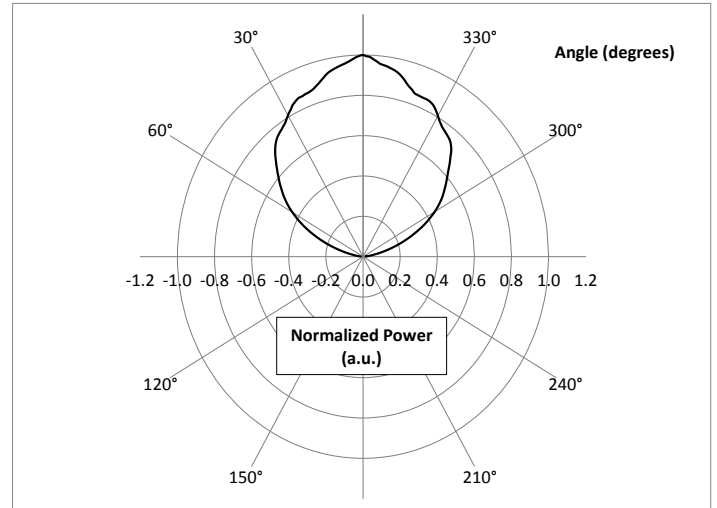

## Thermal Resistance

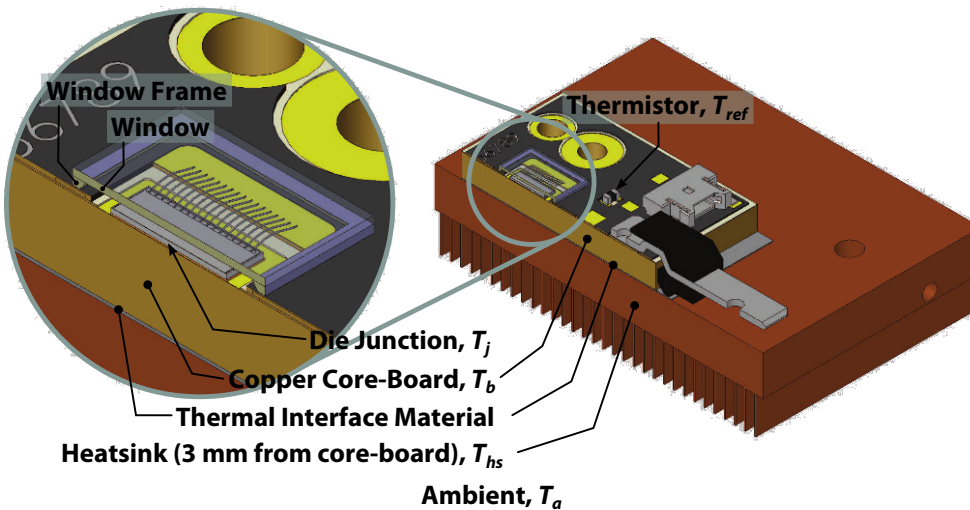

Typical Thermal Resistance

$R_{\theta j-b}^1$	0.80 °C/W
$R_{\theta b-hs}^1$	0.12 °C/W
$R_{\theta j-hs}^2$	0.92 °C/W
$R_{\theta j-ref}^1$	0.83 °C/W

Note 1: Thermal resistance values are based on FEA model results correlated to measured  $R_{\theta j-hs}$  data.

Note 2: Thermal Resistance is based on eGraf 1205 Thermal interface.

## Thermistor Information

The thermistor used in CBT-90 devices mounted on coreboards is from Murata Manufacturing Co. The global part number is NCP15XH103J03RC. Please see <http://www.murata.com/> for details on calculating thermistor temperature.

For more information on use of the thermistor, please contact Luminus directly.

## Electrical Pinout

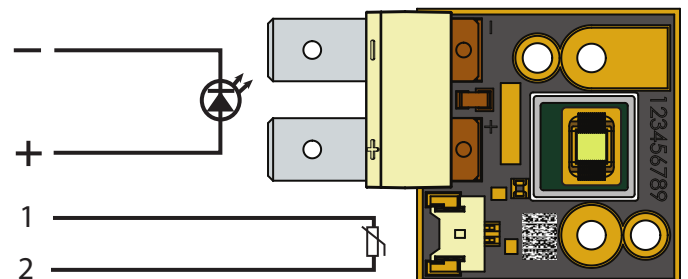

**Mechanical Dimensions – CBT-90-UV Emitter**

DIMENSIONS IN MILLIMETERS

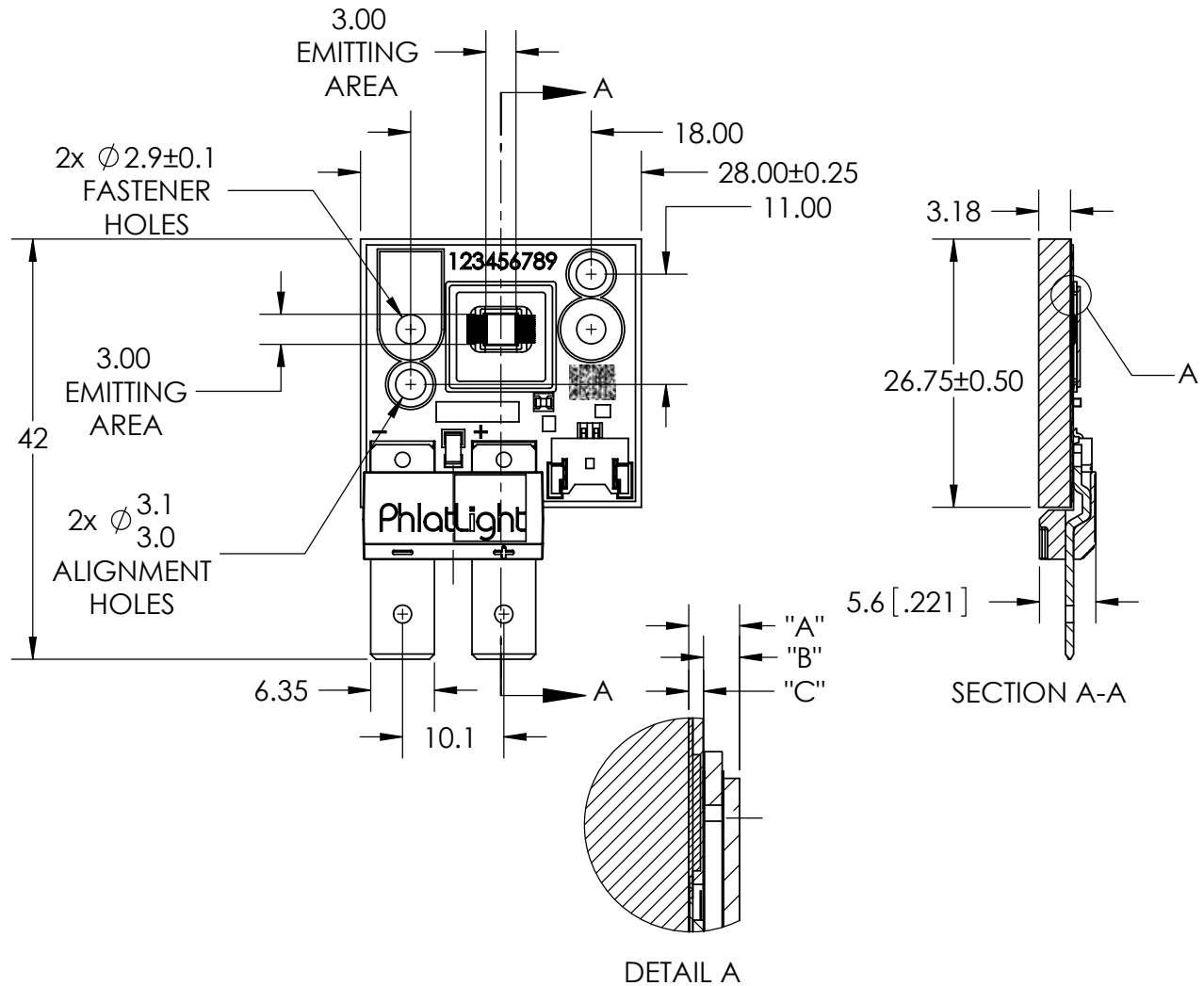

DIMENSION NAME	DESCRIPTION	NOMINAL DIMENSION	TOLERANCE
"A"	TOP OF METAL SUBSTRATE TO TOP OF GLASS	0.95	$\pm 0.13$
"B"	EMITTING AREA TO TOP OF GLASS	0.67	$\pm 0.16$
"C"	TOP OF METAL SUBSTRATE TO EMITTING AREA	0.28	$\pm 0.05$

Recommended connector for Anode and Cathode: Panduit Disco Lok™ Series P/N: DNG14-250FL-C.

Thermistor Connector: MOLEX P/N 53780-0270. Recommended Female: MOLEX P/N 51146-0200 or equivalent.

### Shipping Tray Outline

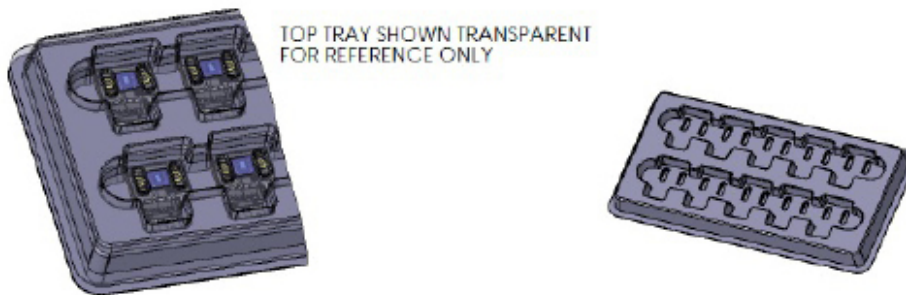
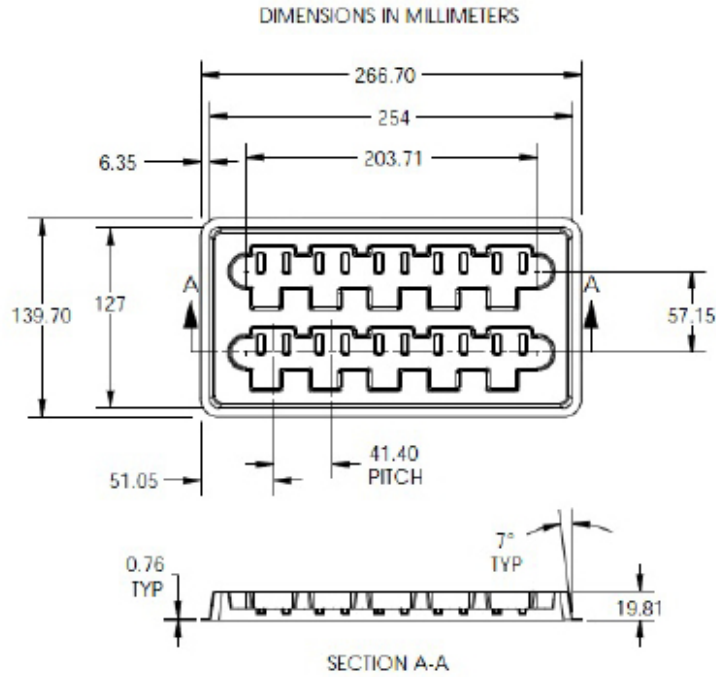

For detailed drawing of shipping trays, please refer to document TO-0479, available upon request.



## Packing and Shipping Specification

### Packing Specification

Packing Configuration	Qty /Pack	Reel Dimensions (diameter x W, mm)	Gross Weight (kg)
Stack of 5 trays with 10 devices per tray Each pack is enclosed in ESD bag	50	150 x 280 x 85	2.7

### Product Label Specification

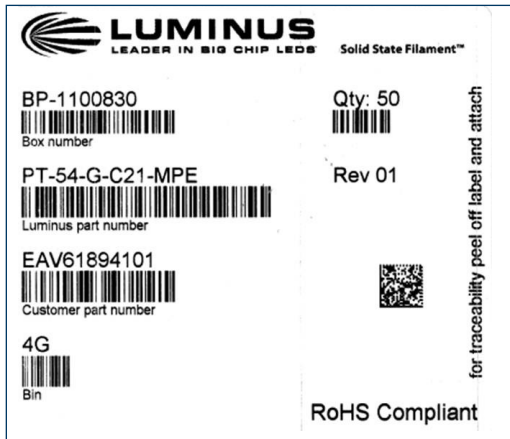

Sample label –for illustration only



#### Label Fields: (Label fields are subject to change)

- 6-8 digit Box number (for Luminus internal use)
- Luminus ordering part number
- Quantity of devices in pack
- Part number revision (for Luminus internal use)
- Customer's part number (optional)
- Flux Bin
- 2D Bar code

### Shipping Box

Shipping Box	Quantity	Material	Dimensions (L x W x H, mm)
Carton Box	1 -20 packs (50 - 1000 Devices)	S4651	560 x 560 x 200



### History of Changes

Rev		Description of Change
A	2012 Apr	Draft Revision



The products, their specifications and other information appearing in this document are subject to change by Luminus Devices without notice. Luminus Devices assumes no liability for errors that may appear in this document, and no liability otherwise arising from the application or use of the product or information contained herein. None of the information provided herein should be considered to be a representation of the fitness or suitability of the product for any particular application or as any other form of warranty. Luminus Devices' product warranties are limited to only such warranties as accompany a purchase contract or purchase order for such products. Nothing herein is to be construed as constituting an additional warranty. No information contained in this publication may be considered as a waiver by Luminus Devices of any intellectual property rights that Luminus Devices may have in such information. Big Chip LEDs™ is a registered trademark of Luminus Devices, Inc., all rights reserved.

This product is protected by U.S. Patents 6,831,302; 7,074,631; 7,083,993; 7,084,434; 7,098,589; 7,105,861; 7,138,666; 7,166,870; 7,166,871; 7,170,100; 7,196,354; 7,211,831; 7,262,550; 7,274,043; 7,301,271; 7,341,880; 7,344,903; 7,345,416; 7,348,603; 7,388,233; 7,391,059 Patents Pending in the U.S. and other countries.