

SHARP

SPEC. No. DG063016

ISSUE

Apr-20-06

REFERENCE

COMPOUND SEMICONDUCTOR SYSTEMS DIVISION

ELECTRONIC COMPONENTS GROUP

SHARP CORPORATION

SPECIFICATION

DEVICE SPECIFICATION FOR
LIGHT EMITTING DIODE

MODEL No. GM5WA06256A

Specified for

CUSTOMERS' APPROVAL

Date _____

By _____

PRESENTED

Date Apr-21-06

By S. Yokota

S. Yokota
Center Chief
LED Business Development Center
Compound Semiconductor Systems Division
Electronic Components (Elecom) Group
SHARP CORPORATION

REFERENCE

PRODUCT NAME Light Emitting Diode
 MODEL No. GM5WA06256A

1. These specification sheets include materials protected under the copyright of Sharp Corporation ("Sharp"). Please do not reproduce or cause anyone to reproduce them without Sharp's consent.
2. When using this product, please observe the absolute maximum ratings and the instructions for use outlined in these specification sheets, as well as the precautions mentioned below. Sharp assumes no responsibility for any damage resulting from use of the product which does not comply with the absolute maximum ratings and the instructions included in these specification sheets, and the precautions mentioned below.

(Precautions)

- (1) This product is designed for use in the following application areas;

* OA equipment * Audio visual equipment * Home appliance
 * Telecommunication equipment (Terminal) * Measuring equipment
 * Tooling machines * Computers

If the use of the product in the above application areas is for equipment listed in paragraphs (2) or (3), please be sure to observe the precautions given in those respective paragraphs.

- (2) Appropriate measures, such as fail-safe design and redundant design considering the safety design of the overall system and equipment, should be taken to ensure reliability and safety when this product is used for equipment which demands high reliability and safety in function and precision, such as ;

* Transportation control and safety equipment (aircraft, train, automobile etc.)
 * Traffic signals * Gas leakage sensor breakers * Rescue and security equipment
 * Other safety equipment

- (3) Please do not use this product for equipment which require extremely high reliability and safety in function and precision, such as ;

* Space equipment * Telecommunication equipment (for trunk lines)
 * Nuclear power control equipment * Medical equipment

- (4) Please contact and consult with a Sharp sales representative if there are any questions regarding interpretation of the above three paragraphs.

3: Please contact and consult with a Sharp sales representative for any questions about this product.

SHARP**REFERENCE**GM5WA06256A specification

1. Application

This specification applies to the outlines and characteristics of the light emitting diode device
Model No. GM5WA06256A. [AlGaInP/GaP red chip LED, InGaN green and blue chip LED device]

2. Outline dimensions and terminal connections ----- Refer to the attached sheet Page 3.

3. Ratings and characteristics ----- Refer to the attached sheet Page 4 ~ 8.

- 3-1. Absolute maximum ratings
- 3-2. Electro-optical characteristics
- 3-3. Derating Curve
- 3-4. Characteristics Diagram

4. Reliability ----- Refer to the attached sheet Page 9.

- 4-1. Test items and test conditions
- 4-2. Measurement items and failure judgment criteria

5. Quality level ----- Refer to the attached sheet Page 10.

- 5-1. Applied standard
- 5-2. Sampling method
- 5-3. Test items, Defect judgment criteria and classification of defect

6. Supplement ----- Refer to the attached sheet Page 11 ~ 13

- 6-1. Taping
- 6-2. Packing Specification
- 6-3. Label
- 6-4. Chromaticity rank
- 6-5. About the environment

7. Precautions for use ----- Refer to the attached sheet Page 14 ~ 15

- 7-1. General description for use
- 7-2. Soldering conditions
- 7-3. For cleaning

SHARP

REFERENCE

2. Outline dimensions and terminal connections

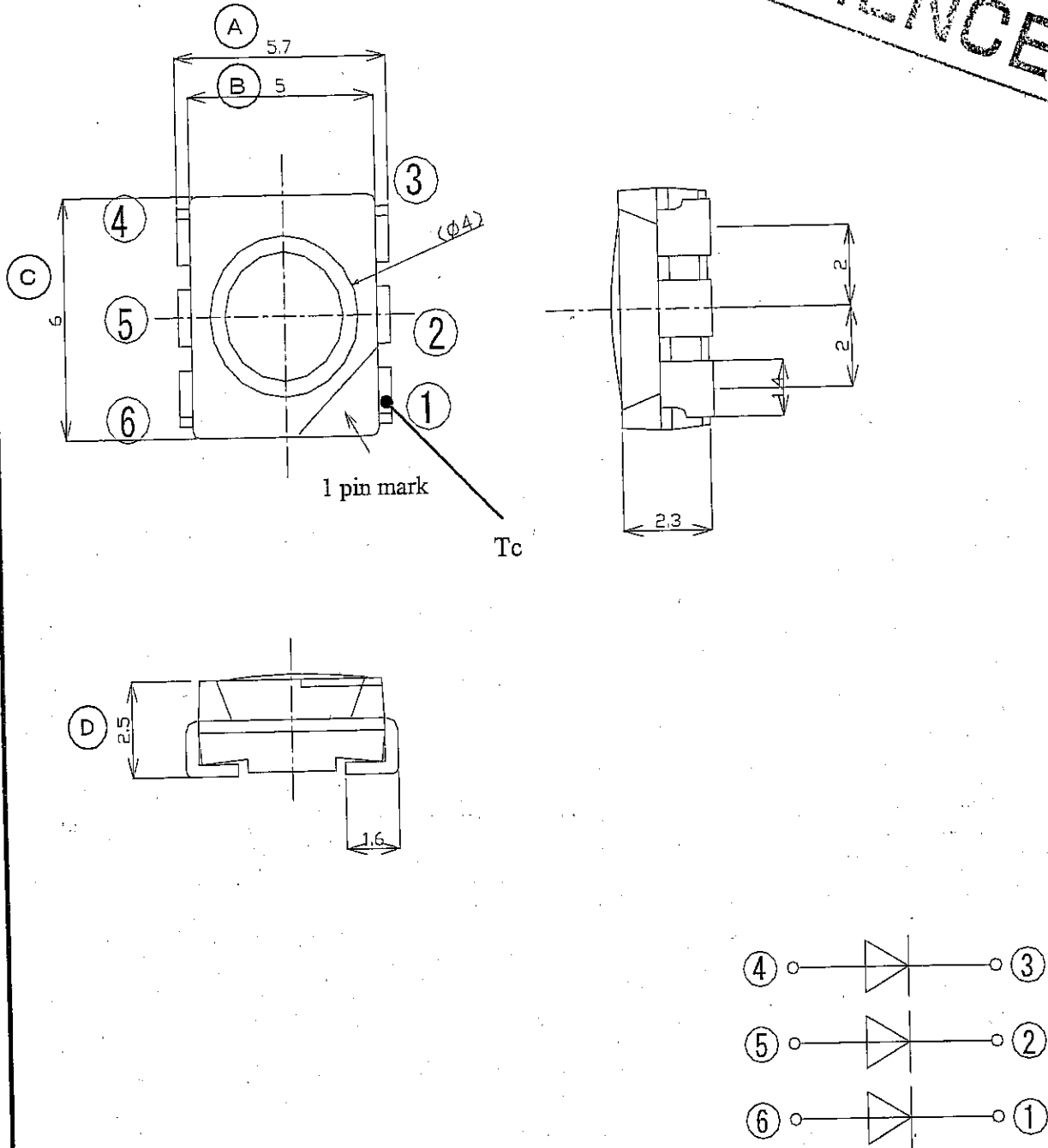

Notes.

1. Terminal Connections ① Blue Cathode ② Red Cathode ③ Green Cathode ④ Green Anode ⑤ Red Anode ⑥ Blue Anode
2. Unspecified tolerance to be ± 0.3
3. Dimensions in () are reference values.
4. Tc: (Case Temperature) It is the maximum temperature of the three cathode terminals.

unit	Material	Finish	
mm	Frame : Copper alloy Resin : Nylon(UL94) / Epoxy	Tin alloy	51803014

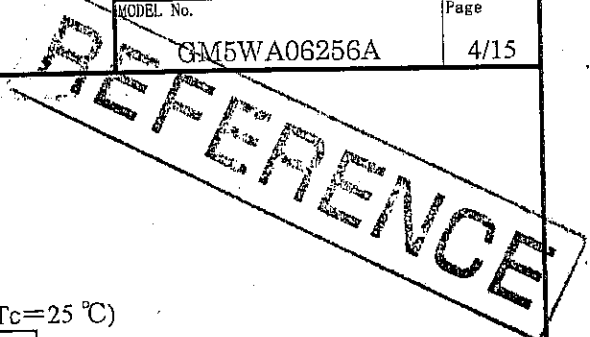

3. Ratings and characteristics

3-1. Absolute maximum ratings

(Tc=25 °C)

Parameter	Symbol	Rating			Unit
		Red	Green	Blue	
Power dissipation	P	400			mW
Continuous forward current(*1)	I _F	50	50	50	mA
Peak forward current (*2)	I _{FM}	80	80	80	mA
Derating factor	DC	1.43	1.43	1.43	mA/°C
	Pulse	2.28	2.28	2.28	mA/°C
Reverse voltage	V _R	5	5	5	V
Operating temperature(*3)	Tc(*3)	-30 to +85(*5)			°C
Storage temperature(*3)	Tstg	-40to +85			°C
Soldering temperature(*4)	Tsol	295			°C

(*1) Rating of each color. Using mixed color, within power dissipation.

(*2) Duty ratio ≤ 1/10, Pulse width ≤ 0.1 ms

(*3) Case temperature(See page 3/15 2.outline dimensions and terminal connections)

(*4) Each terminal is to go to the tip of soldering iron temprtaure less than 295°C for 3 seconds within once in less than the soldering iron capacity 30W.

(*5) The operation current value follows the derating curve. (See page 5/15 3-3 Derating curve)

3-2. Electro-optical characteristics

(Tc=25 °C)

Parameter		Symbol	Condition	MIN.	TYP.	MAX.	Unit
Forward Voltage	Red	V _F	I _F =35 mA	1.8	2.3	2.9	V
	Green			3.2	3.7	4.3	
	Blue			3.2	3.7	4.3	
Luminous intensity (mixed color) (*6)		I _V	Red:I _F =22mA	1100	1500	1850	mcd
chromaticity (mixed color) (*7)	The area enclosed by 4 points of color coordinates	region	Green:I _F =35mA	x	y		
		point 1		0.275	0.318		
		point 2	Blue:I _F =13mA	0.325	0.331		
		point 3		0.275	0.268		
		point 4		0.325	0.281		
Reverse Current	Red	I _R	V _R =4V	-	-	100	μA
	Green			-	-	100	
	Blue			-	-	100	

(*6) Measured by EG&G MODEL550(Radiometer/Photometersystem) after 20ms drive (Tolerance : ±15%)

(*7) Measured by Ohtsuka electronics MODEL MCPD-2000 after 9.6ms drive
This rank is the setting value of when that classifies it the rank and be not a guarantee value.
(Tolerance : x,y:±0.02)

See page 13/15 6-4-1 chromaticity rank table.

REFERENCE
 MODEL GM6WA06256A Page 5/15

SHARP

3-3. Derating Curve

*The graphs of 'forward current derating curve', 'Peak forward current derating curve' and 'Peak forward current vs. duty ratio(Tc=25°C)' are applied for 1 chip-operation.

*Power dissipation derating curve is applied for 3 chips-operation. However, 'forward current derating curve' for 1chip-operation is the prior limitation.

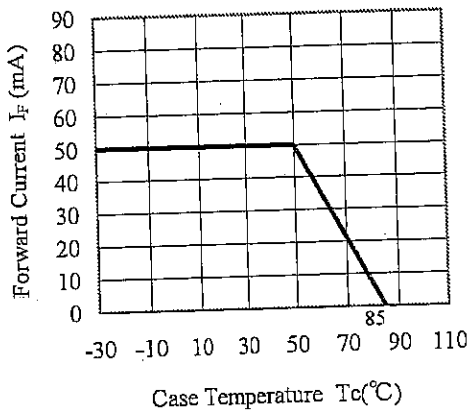

Forward Current Derating Curve

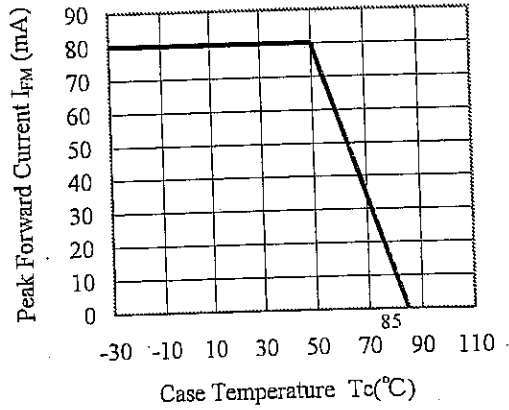

Peak Forward Current Derating Curve
Duty ratio = 1/10, Pulse width = 0.1 ms

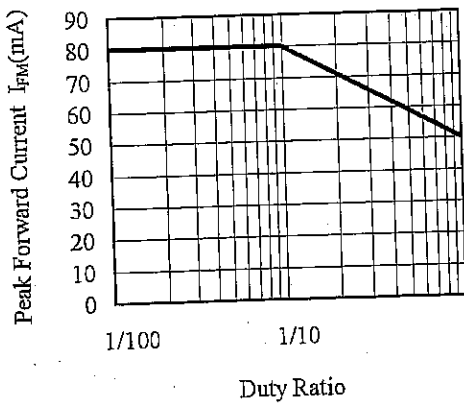

Peak Forward Current vs. Duty Ratio ($T_c=25^\circ\text{C}$)
Pulse width 0.1ms

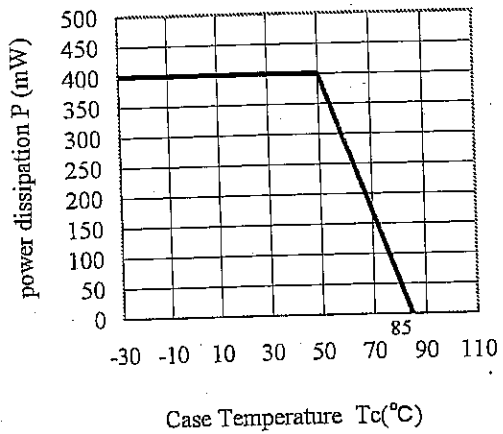

Power dissipation Derating Curve

REFERENCE



3-4. Characteristics Diagram (TYP.)

3-4-1. Characteristics of RED

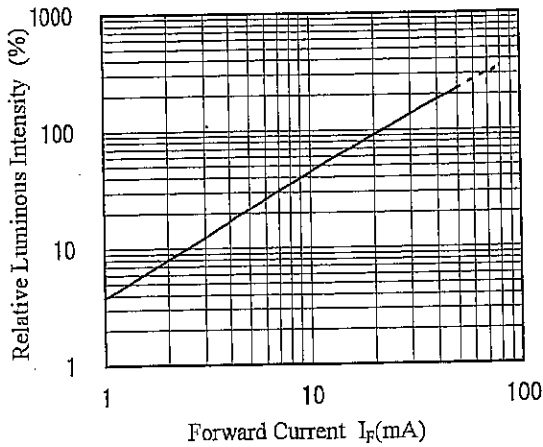

Relative Luminous Intensity vs. Forward Current (Tc=25 °C)

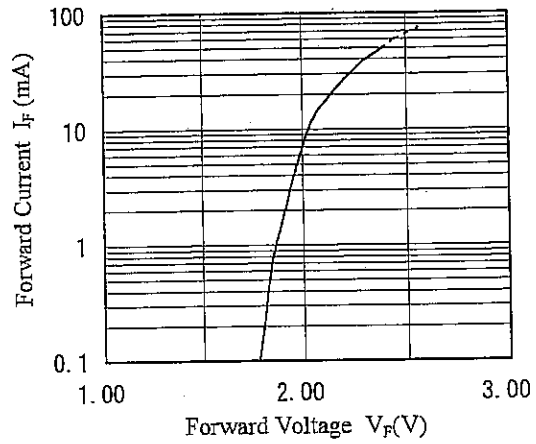

Forward Current vs. Forward Voltage (Tc=25 °C)

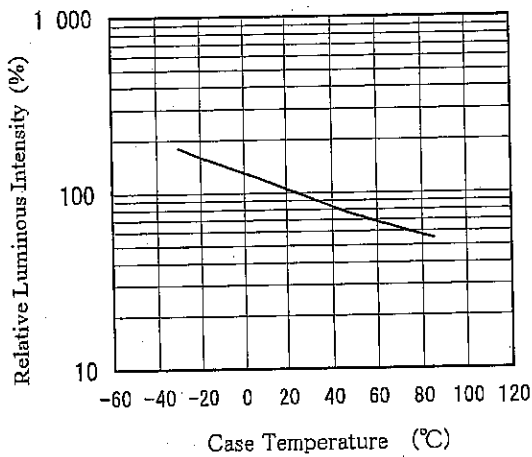

Relative Luminous Intensity vs. Case Temperature

(Note) Data shown here represent typical values and are reference purpose only. (not guaranteed value)

REFERENCE

SHARP

3-4. Characteristics Diagram (TYP.)

3-4-2. Characteristics of GREEN

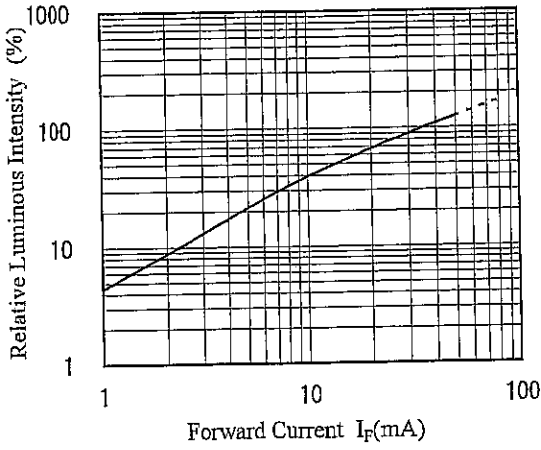

Relative Luminous Intensity vs. Forward Current ($T_c=25^\circ\text{C}$)

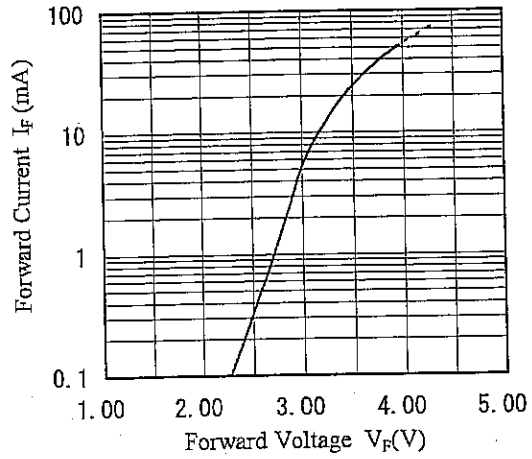

Forward Current vs. Forward Voltage ($T_c=25^\circ\text{C}$)

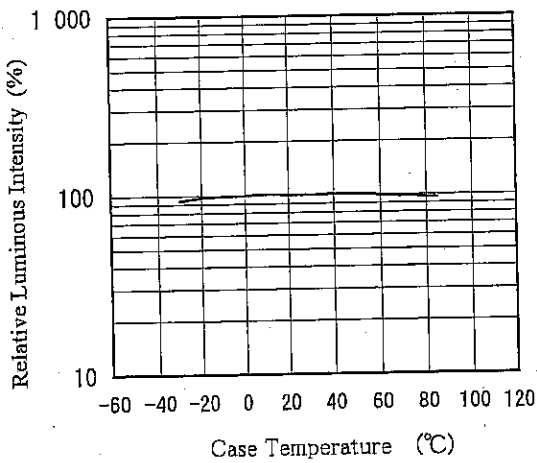

Relative Luminous Intensity vs. Case Temperature.

(Note) Data shown here represent typical values and are reference purpose only. (not guaranteed value)

REFERENCE

SHARP

3-4. Characteristics Diagram (TYP.)

3-4-3. Characteristics of BLUE

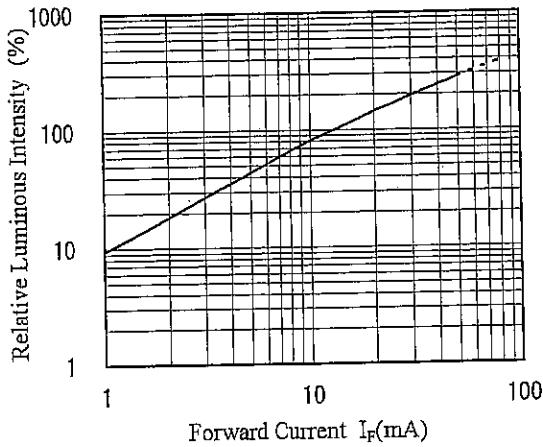

Relative Luminous Intensity vs. Forward Current (T_c=25 °C)

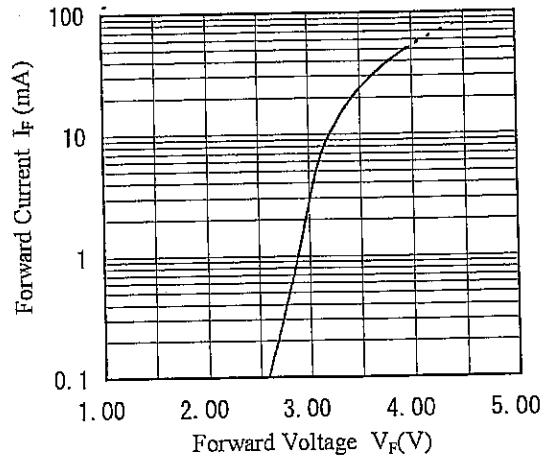

Forward Current vs. Forward Voltage (T_c=25 °C)

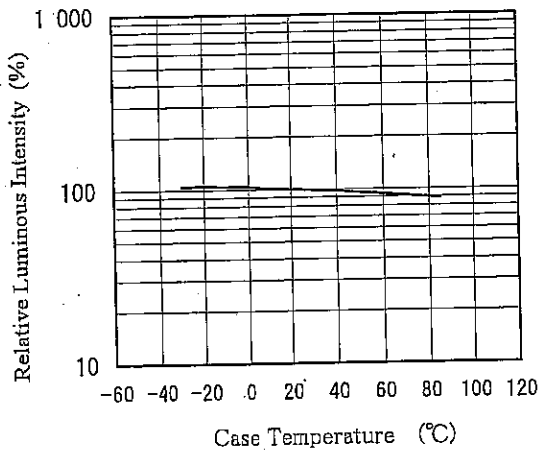

Relative Luminous Intensity vs. Case Temperature

(Note) Data shown here represent typical values and are reference purpose only. (not guaranteed value)

SHARP**REFERENCE**

4. Reliability

The reliability of products shall be satisfied with items listed below.

4-1. Test items and test conditions

Confidence level: 90%

No.	Test items	Test conditions	Samples n	Defective C	LTPD (%)
1	Temperature cycle	-40 °C(30 min)~+85 °C(30 min),30 cycles	22	0	10
2	High temp and high humidity storage	Tstg=+60 °C, RH=90 %, t=1 000 h	22	0	10
3	High temperature storage	Tstg=+85°C, t=1 000 h	22	0	10
4	Low temperature storage	Tstg=-40°C, t=1 000 h	22	0	10
5	Operating test	Tc=+50 °C, I _F =35mA(each color), t=1 000 h [mixed color]	22	0	10
6	Mechanical shock	15 000 m/s ² , 0.5 ms ±X·±Y·±Z direction, 3 times (Tc=25°C)	11	0	20
7	Variable frequency vibration	200 m/s ² , 100~2 000~100 Hz / sweep for 4 min. X·Y·Z direction, 4 times (Tc=25°C)	11	0	20
8	Soldering temperature	Refer to the attached sheet, Page 14/15, 2 times	11	0	20

4-2. Measurement items and failure judgment criteria (*1)

No.	Measurement	Symbol	Failure judgment criteria (*2)
1	Forward voltage	V _F	V _F > U.S.L × 1.2
2	Reverse current	I _R	I _R > U.S.L × 2.0
3	Luminous intensity(*3)	I _V	I _v < Initial value × 0.5, I _v > Initial value × 2.0

*1 : Measuring condition is in accordance with specification.

*2 : U.S.L. : Upper Specification Limit.

*3 : Mixed color

SHARP

5. Quality level

5-1. Applied standard
ISO2859-1

5-2. Sampling method

A single sampling plan, normal inspection level S-4.

5-3. Test items, Defect judgment criteria and classification of defect

No.	Test items	Defect judgment	Defect	AQL
1	No emission	Not emitting light	Major defect	0.1 %
2	Radiation color	Different color against prescribed in the page 4/15.		
3	Taping	Product inserted in reverse direction		
4	Electro-optical characteristics	Not satisfied with specification value (page 4/15) for VF, IR, Iv.	Minor defect	0.4%
5	Outline dimensions	Not satisfied with specification value (page 3/15) for outline dimension.[A to D]		
6	Appearance	Foreign matter or scratch is not good in appearance. Resin burr with sticking exceed the dimension 0.2mm. Crack in resin or terminal over than 0.3mm		

REFERENCE

SHARP

6. Supplement

6-1. Taping

6-1-1. Shape and dimension of tape (Reference value.)

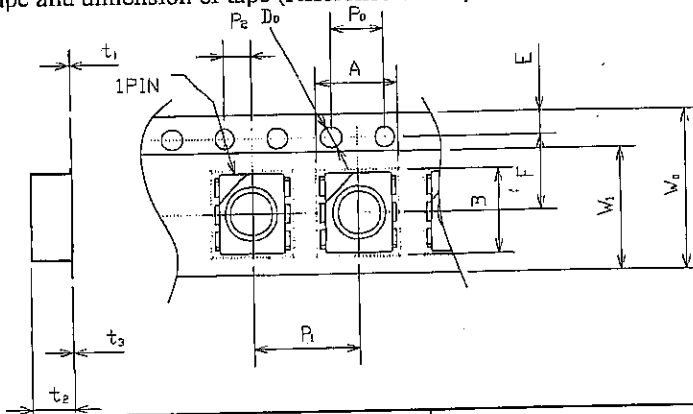

Parameter	Symbol	Dimension [mm] (Ref.)	Remarks	
Concave square hole for part insertion	Vertical	A	6.1	Dimension exclude a corner R at inside bottom
	Horizontal	B	6.4	
	Pitch	P_1	8.0	
Round sprocket hole	Diameter	D_o	1.55	Accumulated error $\pm 0.5\text{mm}/10$ pitch
	Pitch	P_o	4.0	
	Position	E	1.75	
Center to center distance	Vertical	P_2	2.0	Distance between tape edge and hole center
	Horizontal	F	5.65	
Cover tape	Width	W_1	9.2	
	Thickness	t_3	0.1	
Carrier tape	Width	W_0	12.0	
	Thickness	t_1	0.3	
Thickness of entire unit	t_2	3.1	With cover tape and carrier tape combined	

6-1-2. Shape and dimension of reel (Reference value.)

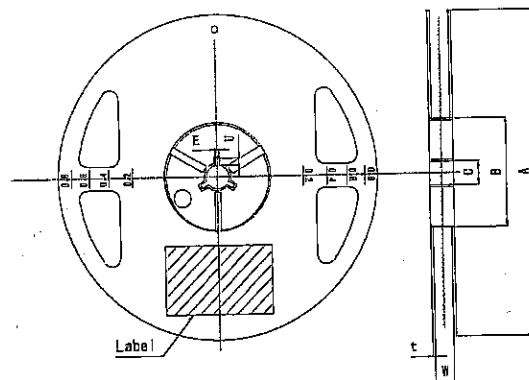

Parameter	Symbol	Dimension [mm] (Ref.)	Remarks
Frange	Diameter	A	$\phi 180$
	Thickness	t	1.5
	Inner space direction	W	13.5
Hub	External diameter	B	$\phi 60$
	Spindle hole diameter	C	$\phi 13$
	Key slit	Width	E
Depth		U	4.5
Notation for part name etc.		Labeling on the side of the frange. (part name, quantity, lot No.)	

※Material: polystyrene

SHARP

6-1-3. Taping specification

(1) Lead tape:

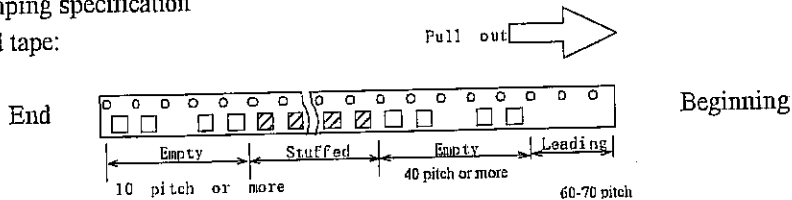
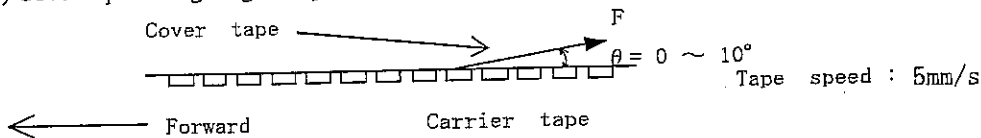
(2) Cover tape strength against peeling: $F=0.1\sim0.8N$ ($\theta=10^\circ$ or less)

(3) Tape strength against bending:

The radius of bending circle should be 30mm or more.

If it is less than 30mm, the cover may peel.

(4) Jointing of tape: There should not be joint of cover tape or carrier tape.

(5) Quantity per reel Average 800pcs. per reel

(6) Packing mass: 200g(One packing/Reference)

(7) Product mass: 0.17g(One product/Reference)

(8) Others:

- ① There must be no such wrong enclosing in the stuffed area as an upside-down product or an external defect product enclosing.
- ② A sequenced omission of the product in the stuffed area is not permitted unless the omission is only 1 piece of LED.
- ③ Products should be easily taken out.
- ④ Products should not be attached to the cover tape at peeling.

6-2. Packing specification

6-2-1. Damp proof package

In other to avoid the absorption of humidity in transport and storage, the devices are packed in aluminum sleeve.

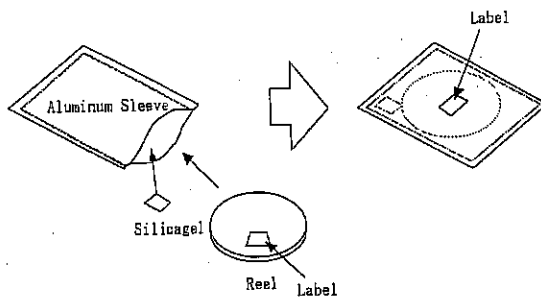

6-2-2. Storage conditions

Temperature : 5 to 30°C Humidity : less than 60%RH

6-2-3. Handling method after opening

- (1) Please keep the devices under the following condition after opening the packages, and make a soldering within 3 days.

Temperature : 5 to 30°C Humidity : less than 60%RH

- (2) In case the devices are not used for a long time after opening, the storage in dry box is recommendable. Or it is better to repack the devices with a desiccative by the sealer and put them in the same storage conditions as 6-2-2.

- (3) Please make a soldering after a following baking treatment if unused term should be over the conditions of (2)

*Recommendable conditions:

- ① in taping
Temperature: 60°C to 65°C, Time: 36 to 48 hours
- ② in individual (on PWB or metallic tray)
Temperature: 100°C to 120°C, Time: 12 hours to 15 hours

Please note that distortion of the reel etc. might be caused by the baking when the baking is done under the stress or with the products piled up. Please confirm that the product is cooled to the room temperature after the baking.

REFERENCE



6-3. Label

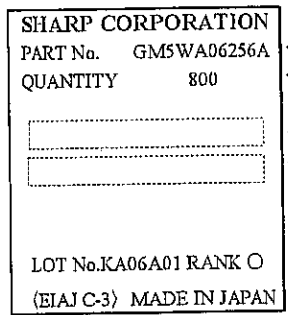

← Model number
 ← Quantity of products
 ← EIAJ C-3 Bar code
 ← EIAJ C-3 Bar code
 ← Lot number and Chromaticity rank
 ← Production country

Lot Number

K A 0 6 A 0 1
 ① ② ③ ④ ⑤

- ① Production plant code(to be alphabet)
- ② Auxiliary code
- ③ Year of production(the last two figures of the year)
- ④ Month of production
(indicated with alphabet, January corresponding to A)
- ⑤ Date of production(01~31)

Rank

○ ○:Chromaticity

6-4. Chromaticity rank (*1)

6-4-1 chromaticity rank table(*1)

(Tc=25 °C)

chromaticity rank	chromaticity (x,y)								condition
	point 1		point 2		point 3		point 4		
	x	y	x	y	x	y	x	y	
a	0.275	0.318	0.300	0.325	0.275	0.293	0.300	0.300	R : I _F =22mA G : I _F =35mA B : I _F =13mA
b	0.300	0.325	0.325	0.331	0.300	0.300	0.325	0.306	
c	0.275	0.293	0.300	0.300	0.275	0.268	0.300	0.275	
d	0.300	0.300	0.325	0.306	0.300	0.275	0.325	0.281	

6-4-2 chromaticity rank graph

(Tolerance : x,y:±0.02)

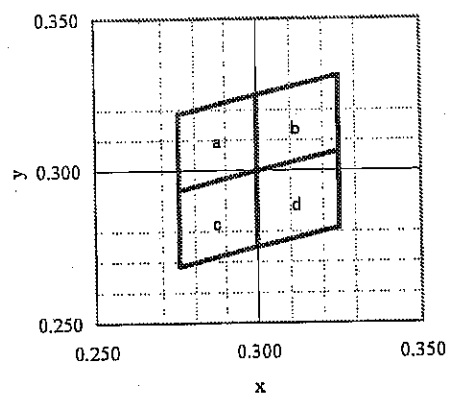

[note] 1) Shipment to be conducted without regard to rank ratio.

2) To use mixed color, within power dissipation then adjust current of each color.

6-5. About the environment

6-5-1. The existence of the Ozonosphere destructive chemicals.

- (1) The device doesn't contain following substance.
- (2) The device doesn't have a production line whose process requires following substance.
 Restricted part : CFCs,halones,CCl₄,Trichloroethane(Methylchloroform)

6-5-2. The existence of the Bromic non-burning materials

The device doesn't contain bromic non-burning materials(PBBOs,PBBs)

REFERENCE



7. Precautions for use

7-1. General description for use

- (1) When designing a circuit, please make sure that no reverse voltage is biased to the LED
 There is a case that LED is damaged with external stresses since the devices are very small.
 Please make sure that no shock is given to the LED after assembling.
- (2) Please don't look straight for a long time at the LED under High power operation, which may damage your eyes.
- (3) This device uses the material with high conduction of heat to make heat generated by LED radiate outside of the device easily.
 Therefore, it might be damaged when the heat source is close.
 *Please design the temperature of the case to become 85°C or less including self-generation of heat.

7-2. Soldering

7-2-1. Reflow soldering

- (1) It is not recommended to exceed the soldering temperature and time shown below.
 Caused by substrate bend or the other mechanical stress during reflow soldering may happen gold wire disconnection etc. Therefore please check and study your solder reflow machine's best condition.
- (2) In case of 2 times reflow process, 2nd reflow process should be done within 3 days after 1st reflow process. (Storage condition; at 30°C, RH less than 60%RH)
- (3) This device is not designed for the dip soldering.
- (4) Reflow soldering temperature profile
 Use the conditions shown to the under figure.
 (After reflow soldering, rapid cooling should be avoided.)

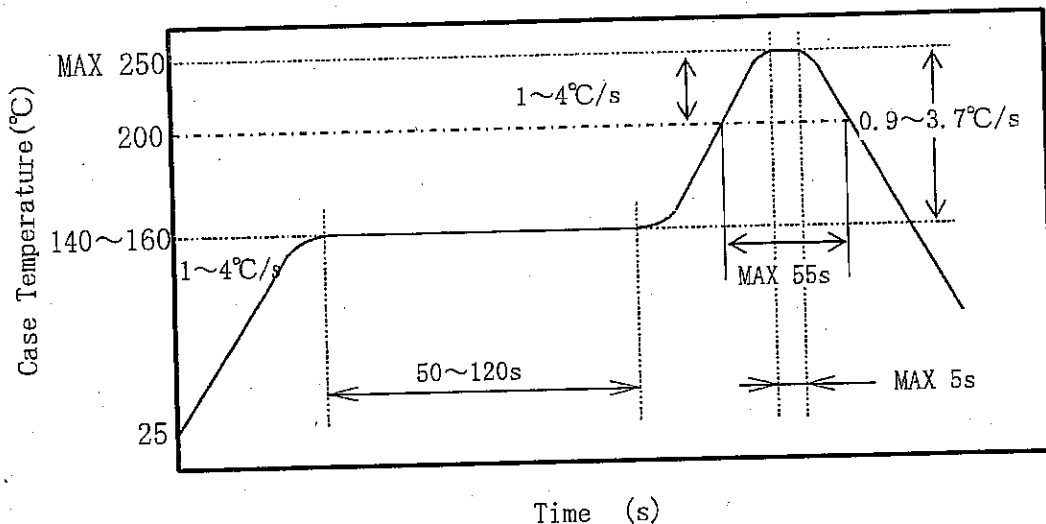

Fig. Reflow soldering temperature profile

REFERENCE

SHARP

(5) N₂ reflow can be used.

(6) Precaution for 2nd reflow

Please set the number of reflow once, basically. When the 2nd reflow is required and unavoidable, the 2nd should be soon after the 1st.

Especially in case that there is a water-washing process or a solvent-washing process after the 1st-reflow, please dry each product by baking under the condition of page.12 6-2-3(3), before the 2nd reflow.

(7) Reflow soldering temperature profile

In case that the PWB backside is designed to be dipped, the heat or the warp of the PWB is likely to cause mechanical stress. To relieve the stress, the reflow for the product should be after dipping.

7-2-2. Recommendable pattern

(1) Metal mask that is 0.2mm to 0.3mm thick is recommended for screen printing.

Caused by solder reflow condition, solder paste, substrate and the other material etc., mask may change solderability. Please check and study actual solderability before usage.

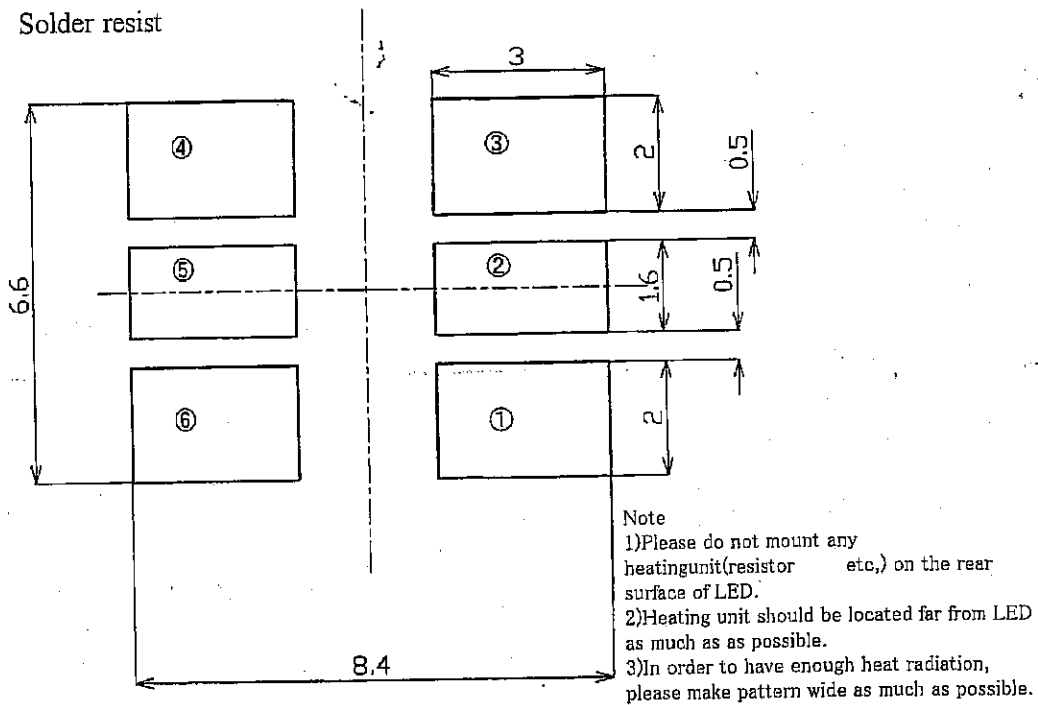

7-3. For cleaning

Carry it out about washing with contents of the following.

- (1) Solvent cleaning: Solvent temperature 30°C less. Immersion for 4 min or less.
- (2) Ultrasonic cleaning: The effect to device by ultrasonic cleaning differs by cleaning bath size, ultrasonic power output, cleaning time, PWB size or device mounting condition etc. Please test it in actual using condition and confirm that doesn't occur any defect before starting the ultrasonic.
- (3) Applicable solvent: Water, Ethyl alcohol, Isopropyl alcohol

In case when the other solvent is used, there are cases that the packaging resin is eroded. Please use the other solvent after thorough confirmation is performed in actual using condition.